

Installation User Manual

www.beward.net

**IP Video Door Station
DS06M(P)**

Electronic Motorized Lock Control
Multiaccessible User Operation
Built-in IP Video Camera
Two-Way Audio



Contents

CHAPTER 1. SAFETY INSTRUCTIONS	2
CHAPTER 2. DESCRIPTION	4
2.1. KEY FEATURES.....	5
2.2. PACKAGE CONTENTS.....	5
CHAPTER 3. OVERVIEW	6
3.1. DOOR STATION.....	6
3.2. CONTROLLER.....	7
CHAPTER 4. DOOR STATION INSTALLATION	10
4.1. GENERAL INFORMATION.....	10
4.2. INSTALLATION RECOMMENDATIONS.....	11
4.3. DOOR STATION MOUNTING.....	13
4.4. MEMORY CARD INSTALLATION.....	21
4.5. WIRED CONNECTION TO A NETWORK.....	22
CHAPTER 5. WIRED CONNECTION SETTING	23
5.1. DEFINING THE LOCAL NETWORK PARAMETERS FOR WIRED CONNECTION.....	23
5.1.1. <i>Defining the Local Network Parameters When Using a Dynamic IP Address</i>	27
5.2. CHANGING THE LOCAL NETWORK PARAMETERS.....	30
5.3. ACCESSING THE DOOR STATION USING INTERNET EXPLORER.....	34
5.4. ACCESSING THE DOOR STATION WEB INTERFACE.....	34
5.5. CONFIGURING DOOR STATION NETWORK SETTINGS THROUGH THE WEB INTERFACE.....	39
5.6. RESTORING NETWORK SETTINGS OF PC TO THE PREVIOUS VALUES.....	40
5.7. VERIFYING THE CONNECTION SETTINGS.....	43
CHAPTER 6. RECOMMENDATIONS ON SETTING AND OPERATION OF DS06M(P)	46
6.1. ACOUSTIC ECHO CANCELLATION.....	46
6.2. SOUND GAIN AND VOLUME ADJUSTING.....	47
APPENDICES	49
APPENDIX A. FACTORY DEFAULTS.....	49
APPENDIX B. GLOSSARY.....	49

Before using the product.

This product complies with all safety rules. However, improper use of any electric device can cause fires and severe damage. In order to avoid accidents, please read this Manual carefully before you start using this door

ATTENTION!

Use accessories specified by the manufacturer only. Use of improper accessories may cause device breakdown.

Follow this Operation Manual.

Do not use or store the door station in severe environment:

- Avoid extremely low and high temperatures (The operating temperature of this door station is $-40^{\circ}\sim+50^{\circ}$).
- Avoid prolonged exposure to direct sunlight, do not install near water and heat sources.
- Do not install near electromagnetic transmitters
- Avoid exposure to high vibration.

ATTENTION!

Contact our Service Center in case of malfunction.

In case of:

- Smoke or strange smell coming from the door station.
- Water or foreign matter getting inside the door station.
- The door station getting damaged:

Do the following:

- Unplug the power cord and disconnect all other cords from the door station.
- Contact our Service Center. You can find our contact information on our website: <http://www.beward.ru/>.

Transportation

Transport the door station carefully, using the original box and protective packing

Air flow

In order to avoid overheating, ensure that nothing is blocking the air circulation around the door station!

Cleaning

Use a soft dry cloth to clean the surface of the device. To remove obstinate stains, apply a small amount of detergent on the cloth, then wipe the surface dry

Do not use volatile solvents (alcohol-containing products, Benzene etc.) to avoid damaging the door station housing.

Chapter 2. Description

DS06M(P) IP Video Door Station is designed for organizing IP intercome systems based on already existing local networks without using any additional equipment (e.g. separate internal monitors). To start using the door station you only have to install the software from the disk and set it up. Low cost, easy installation and remote access to the. This device is:

- Low-cost
- Easy to install
- Remote Access Supported



Pic. 2.1

DS06M(P) has build-in microphone, speaker, video camera, Infrared LED and a call button, as well as vandal-resistant housing. The device allows establishing video and audio connection between the [Guest](#) and the [Client](#), conducting surveillance of the nearby territory, control of other devices that are connected to the door station (electronic locks, garage door openers, light switches, alarm systems etc.) Infrared LED (with work distance up to 10 m) and the mechanical infrared filter allow conducting video surveillance in low-light level environments. The device is supported by modern network technologies, allowing it to be used a part of a complex IP Surveillance system.

DS06M Door station is connected to the network via-T/100BASE-TX Ethernet interface. Its power is supplied from a DC 12V power source. The device also supports PoE.

The device is even more reliable due to its SD card support that prevents loss of data in case of network failures

2.1.1. Key Features

- Image sensor: 1.3 MP, CMOS 1/3" SONY Exmor™, Day/Night
- Simultaneous encoding: H.264/H264, H.264/MJPEG, MJPEG /MJPEG
- Framerate: Up to 25 fps (all resolutions)
- IR Illumination (distance up to 10 m) and a mechanical IR filter
- 4GB MicroSDHC memory card installed (up to 32GB supported)
- Multistreaming: up to 10 unique streams (only one user can be in the two-way audio mode at one time)
- Built-in web server for viewing and adjusting settings
- Built-in player for recorded videos
- Build-in microphone and speaker
- Power: DC 12 V, 0.5 A / PoE 802.3af Class 0 (for DS06MP only)
- Temperature: -40°C~+50°C
- Supported protocols: TCP/IP, SIP v.2.0, PPTP, HTTP, HTTPS, FTP, SMTP, DDNS, DHCP, PPPoE, RTP, RTSP, UPnP, UDP, NTP, ONVIF v.2.41, Modbus TCP, Camdrive
- ONVIF v.2.41 support

2.1.2. Package contents

- DS06M(P) Door station
- Bracket with mounting kit
- Security screw with L- key
- NC103 / NC103P / NC311P controller
- RJ45-S01 (2 pcs.)
- Terminal block
- CD with software and documentation

ATTENTION!

Package contents and device specification are subject to change without notice

Chapter 3. Overview

3.1. Door Station

A door station front view is given below:

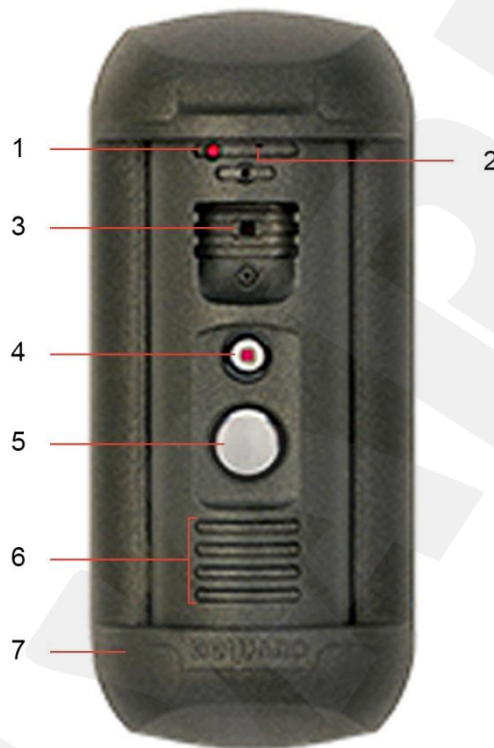

Pic. 3.1

1 – light sensor: a photoelectric cell that allows for automatic switching between Day and Night modes .

2 – built-in microphone: allows the Client to receive sound from the surveillance area.

3 – IP camera: allows the Client to monitor the surveillance area.

4 – IR LED: the infrared light-emitting diodes used instead of standard electric lamps provide video surveillance process at a low light level as well as at nighttime.

5 – call button: a call notification is sent to the Client when the Guest presses this button.

6 – built-in speaker: combined with the built-in microphone it provides a two-way audio channel between the Client and the Guest.

7 – bracket frame: combined with a bracket plate it fixes the door station on the mounting surface.

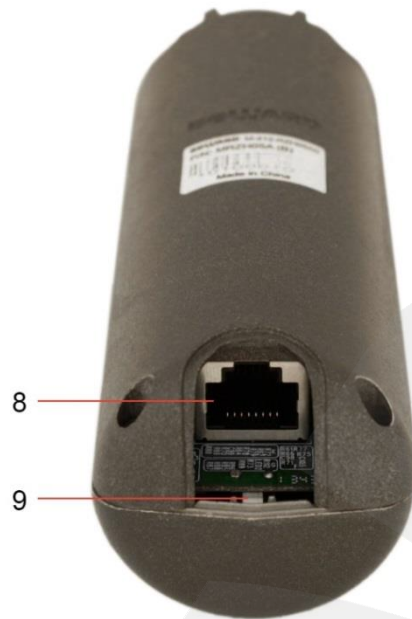

Pic. 3.2

8 – RJ45 socket: is used for connecting the door station to the NC103 / NC103P / NC311P controller via a patch cable.

9 – reset button: press this button 3 times with intervals not less than 1 second during 10 seconds to set door station settings by default.

10 – memory card slot: is situated inside the door station housing, on the upper interface board, from one side.

3.2. Controller

A door station controller is used for powering the door station, network connection, processing the signal of door opening and signals of other devices that can be connected to the door station.

A 1-channel or a 3-channel controller can be included in the DS06M(P) package contents.

There is an **RJ45 socket (“ETHERNET”)** on the front side of the door station controller, which is used for connecting the controller to a router (Pic. 3.3, 3.4).



Pic. 3.3. Controller NC103 / NC103P



Pic. 3.4. Controller NC311P

The front side of the NC311P controller also has the following:

- a light indicator of work state of the controller;
- a “LINK” button which is used for setting interaction between the controller and the door station;

NOTE!

For operation with the NC311P controller (in the DS06MP-3L package contents) it is obligatory to set interaction between the controller and the door station. Press the “LINK” button on the controller and then click **[Connect]** in the menu **Config – Controller** of the door station web user interface when “NC311P” is chosen as a type of a controller (refer to Operation User Manual for details).

The interaction procedure takes about 1 minute from the moment of pressing the “LINK” button.

- “DGU+” technological connector (not used in the current controller model).

Power over Ethernet (PoE) is provided by the NC103P or NC311P controller and a router (or PoE injector) supported PoE 802.3af Class 0.

A rear view of the door station controller is shown on the *Pictures 3.5, 3.6:*



Pic. 3.5. Controller NC103 / NC103P



Pic. 3.6. Controller NC311P

1 –RJ45 socket (“ETHERNET”/“DOOR ST”) is used for connecting the NC103 / NC103P / NC311P controller to the door station via a patch cable. The patch cable should be made using RJ45-S01 connectors from the package contents (see paragraph [4.5](#)).

ATTENTION!

The patch cable must be connected to the door station via an RJ45 connector! It is impossible to connect the door station using any other cable connector .

2 – terminal connector (ALARM OUT): is used for connecting a door lock or another device controller. In case of connection to the 1-channel door station controller, NC103 or NC103P (shown on the *Picture 3.5*), the signal opening the door outputs to the lock controller is transmitted via «1A» and «1B» pins.

In case of the 3-channel NC311P controller , the signal opening the door outputs to the lock controller is transmitted via «1A» and «1B»/«1C», «2A» and «2B»/«2C», «3A» and «3B»/«3C» pins for the first, the second and the third channel accordingly (*Pic. 3.6*). The «A» and «B» pins are normally open, and the «A» and «C» pins are normally closed.

The «G» and «12V» pins of the NC103 controller (without PoE support) are used for DC 12V power supplying of the door station. It is necessary to connect a power supply recommended by BEWARD and the lock controller to these pins.

The «G» and «12V» pins of the NC103P / NC311P controller (with PoE support) are used for powering the lock controller (several lock controllers) with DC 12V. In this case it is necessary to connect only the lock controller to these pins.

ATTENTION!

Use only DC 12V power supplies recommended by BEWARD!

Power supplying using both PoE and the «G» and «12V» pins (for NC103P and NC311P controllers) at one time is prohibited!

ATTENTION!

Maximum current rate provided by the NC103P, NC311P controllers for powering door locks and their controllers is 500 mA. If this value is exceeded the device may malfunction or break. The device breakdown caused by the exceeding of the maximum current rate is not covered by the warranty.

Chapter 4. Door Station Installation

4.1. General Information

The door station can be connected directly to a computer or via a router (a switch).

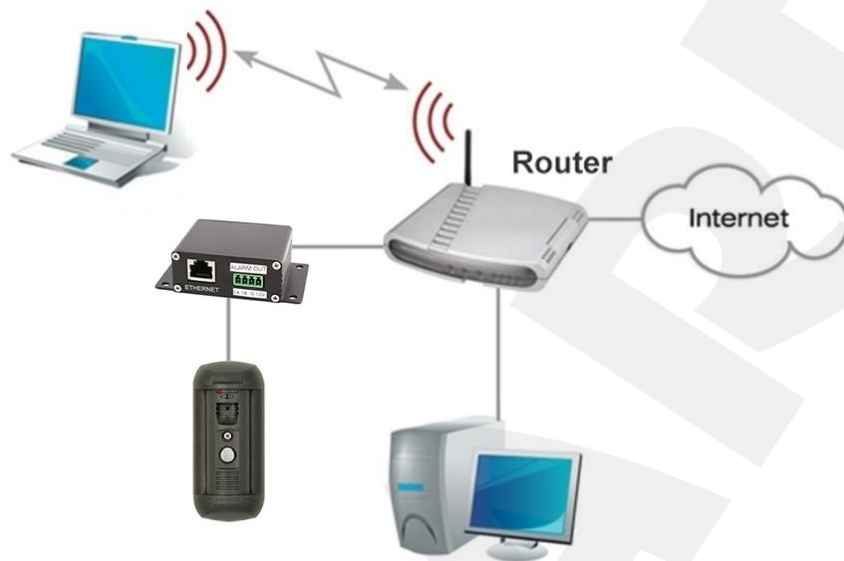

Pic. 4.1

The general instructions and installation recommendations are given below.

4.2. Installation Recommendations

This paragraph contains a short list of recommendations necessary for the correct installation of DS06M(P).

IP Video Door Station DS06M is installed in the dry places on the surface of the inactive leaf of exterior double doors or on the wall of the building. It is recommended to install the device indoors (vestibules, entrance halls), avoiding the outside installation. It is also recommended to lay cables in an ergonomic way.

Install the door station in a well-lighted area avoiding exposure of the camera lens to direct sunlight. The mounting height must be convenient for the Guest to talk with the Client. It is recommended to install the door station at height of about 1.5 m from the floor.

Then it is recommended to provide the uninterrupted power supply of router, door station, electronic lock and its controller.

Recommendations for door station placement:

- The operating temperature range is -40°C to $+50^{\circ}\text{C}$.
- Avoid exposure to direct sunlight and do not locate the door station near any heat sources.
- Incorrect installation may cause undesirable “blind spots”
- Do not locate the door station near any electrical appliances which can be electromagnetic transmitters.
- When installing the door station, make sure the cables are laid in a safe and ergonomic way..
- Avoid unstable installation, which may allow exposure to high vibration. This may reduce motion detection performance and image quality in general.
- The view direction should be clearly determined at the moment of the door station installation.

Recommendations for twisted pair cable routing:

- In corridors, it is advisable to install electric and feeble-current cables in different conduits that are disposed on different walls.
- Twisted pair and electric cables can be installed in the same conduit using different sections of the cable that have solid longitudinal partitions with at least 0.25 h of fire resistance, which are made of non-combustible material and should be positioned in work areas at distance of 15 meters maximum if the electrical power does not exceed 5 kW.
- Electric and feeble-current cables should be placed in parallel to each other at distance of at least 50 mm in different conduits or different sections of conduit. If the electric field strength from the electric cables exceeds 3 V/m, you should increase the distance between the electric and feeble-current cables or reduce the electromagnetic noise.
- Twisted pair and electric cables should cross each other at right angles.
- Unshielded twisted pair cables should be located at distance of at least 125 mm from fluorescent gas-discharge lamps or from other high-voltage discharge devices.
- Unshielded twisted pair cables should be located at distance of at least 1.5 meters from electromagnetic interference sources that produce electric field strength exceeding 3 V/m.
- Switchboards with pinned unshielded twisted pair cables should be located at distance of at least 3 meters from electromagnetic interference sources that produce electric field strength exceeding 3 V/m.
- Cable runs should be arranged between the points of connection such a way so the overall cable path length is as short as possible.
- Minimum cable bending radius is four times the cable diameter (or 1 inch=2.5 cm). It is also acceptable to install the cable so that the cable bending radius is 2 inches (5 cm).
- Maximum length of the entire segment is 100 meters.

4.3. Door Station Mounting

Follow the steps below:

Step 1: take the bracket plate (*Pic. 4.2*). Choose the right height of mounting above the floor. The recommended height is about 1.5 m.

Step 2: mark the holes on the mounting surface using the bracket plate as a template. Drill the holes.



Pic. 4.2

Step 3: insert plastic wall dowels in the holes and fix the bracket plate using four screws. The heads of some other screws you use (not from the package contents) must be not higher than 2.5 mm and not bigger than 9 mm in diameter.

Step 4: there are hidden and open ways of cabling:

- for hidden cabling drill a hole for twisted pair cable output at the distance of 25 mm from the bottom of the bracket plate. Leave 110 mm of the cable outside.
- for open cabling fix a cable channel on the wall so that the distance between the channel and the bottom of the bracket plate would be 36 mm. Leave 110 mm of the cable outside (*Pic. 4.3*).

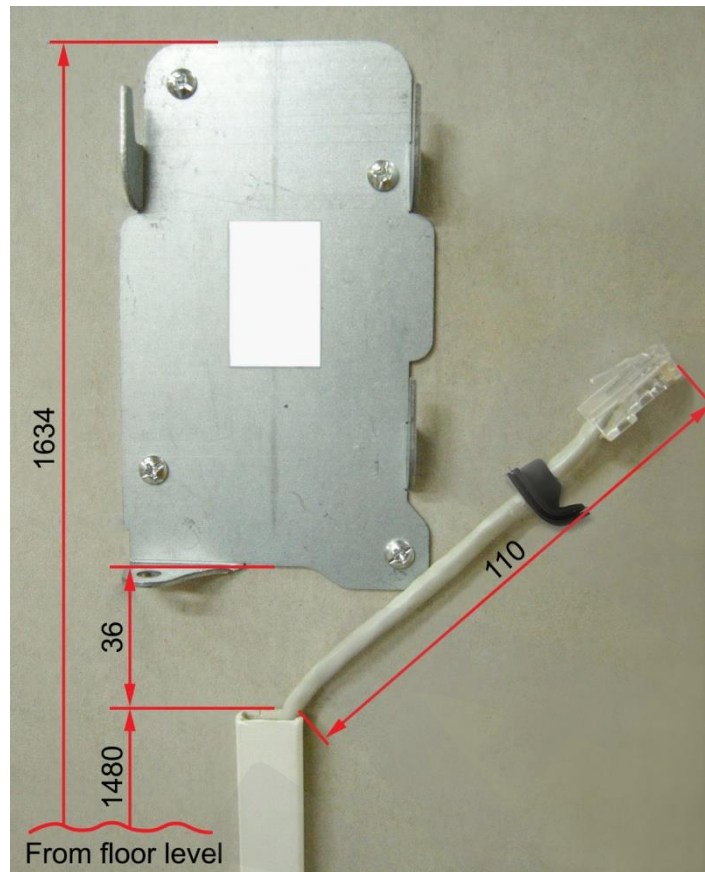

Pic. 4.3

Step 5: before attaching a connector to the twisted pair cable put a rubber seal from the package contents on it to make to seal the connection area (Pic. 4.4).



Pic. 4.4

Step 6: attach the RJ45-S01 connector from the package contents to the twisted pair cable using a crimping tool. For more information on how to crimp a twisted pair cable go to the paragraph [4.5](#).

ATTENTION!

The patch cable must have the RJ45-S01 connector at the end connected to the door station! It is impossible to connect the door station using a cable connector of some other form.

The twisted pair cable (5e UTP/FTP) connected the door station with its controller should be wired the same at both ends (“straight-through” form).

ATTENTION!

The device breakdown caused by wiring the cable in different manner is not covered by the warranty. Use the cable of the minimal possible length to connect the door station and its controller. Proper operation of the device cannot be guaranteed in case of using of the 10 m cable and more.

Step 7: connect the crimped cable to the door station, sealing the connection area, and put it in the bracket frame. Rotate the door station in the frame to set the appropriate view direction of the built-in IP camera. Place a excess part of the cable as it is shown on the picture below:



Pic. 4.5

Step 8: specific notches of the bracket frame and the door station (*Pic. 4.6*) allow the station to be fixed well and prevent loose rotation during operation.



Pic. 4.6

A view direction of the built-in IP-camera must be clearly determined at the moment of the door station installation (rotating angles are $\pm 45^\circ$ from the middle position).

Step 9: apply the door station inserted in the bracket frame to the bracket plate fixed on the wall. Then move them down with force up to the stop. The bracket frame should completely cover the bracket plate, and there should not be any space between the frame and the wall.

Step 10: ensure that the bracket is fixed well. In case of a gap between the bracket frame and the door station, check the joints of the fixation notches. There must be no space between parts if the notches fit each other. If they don't, change door station's position inside the frame to fit it better (Pic. 4.7).

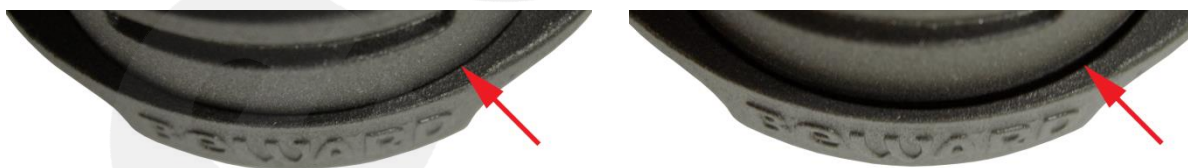

a) Correct installation. There is no gap.

b) There is a gap between door station and bracket.

Pic. 4.7

Step 11: fix the door station inside the bracket frame using the hexagonal socket screw and L-key from the package contents. To do so push the bracket frame down and simultaneously tighten the secret screw up (Pic. 4.8).



Pic. 4.8

Step 12: attach the RJ45 connector to the other end of twisted pair cable using a crimping tool as it described in the paragraph [4.5](#).

ATTENTION!

The twisted pair cable (5e UTP/FTP) connected the door station with its controller should have the same wire arrangement on both ends (“straight-through” form). The device breakdown caused by wiring the cable in different manner is not covered by the warranty.

Step 13: connect the crimped cable to the RJ45 socket (ETHERNET) of the NC103 / NC103P / NC311P controller (Pic. 3.5, 3.6).

Step 14: connect the door lock controller to the terminal block of the door station controller. The recommended connection schemes are given below.

NOTE!

The NC103P controller is shown on the schemes 2, 3 (Pic. 4.10, 4.11). The same schemes can be also used in case of connection of the NC311P controller.

1. Without PoE (DS06M package contents):

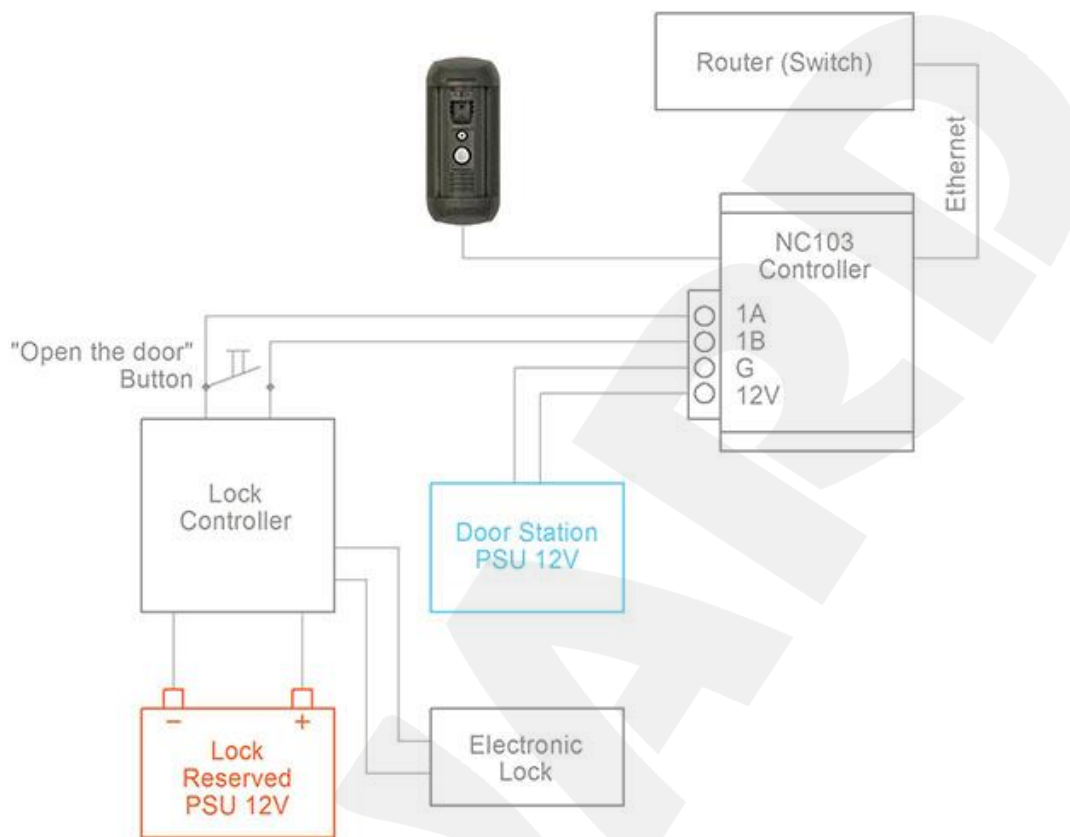

Pic. 4.9

NOTE!

There are two main reasons why it is recommended to use separate power supply units for the door and the door station when using an electronic lock.

The first reason is that the current, powering the door station, has a value comparable to that of the current powering the electronic lock. So the electronic lock power supply unit runs out quickly, powering the door station.

The second reason is that there is a risk of the door opening in case of a short circuit of the external power supply line (door station side).

ATTENTION!

Use only DC 12V power supplies recommended by BEWARD! For recommendations please visit our website (www.beward.net).

It needs to highlight that the maximum current rate provided by the power source for supplying of the door station, door lock and other equipment should not be exceeded.

2. With PoE (DS06MP package contents):

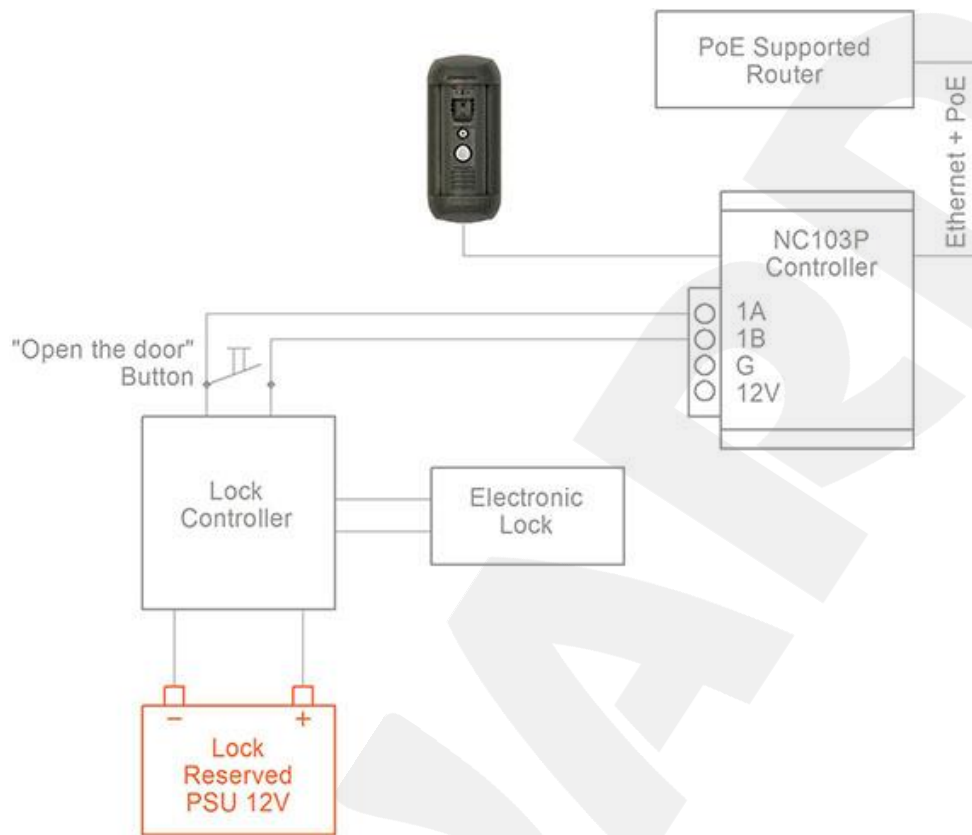

Pic. 4.10

In this case the door lock and its controller are supplied with power by an external 12V power source, but the door station use PoE supplying.

ATTENTION!

Power supplying via both PoE and the «G» and «12V» pins (for NC103P and NC311P controllers) at one time is PROHIBITED!

3. It is available to supply all using devices with PoE (without use of an external power source) if the total energy consumption of using electronic normally closed lock and its controller is not bigger than 500 mA.

In this case the recommended connection scheme is as follows:

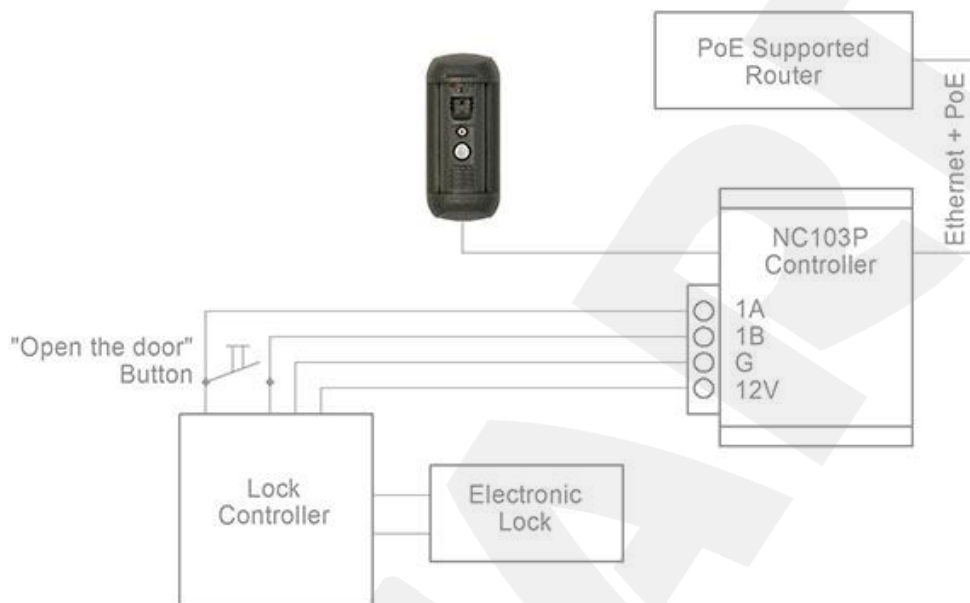

Pic. 4.11

The all devices use PoE supplying on the scheme above.

NOTE!

The current rate of electronic locks specified in their documentation can be exceeded for short time at the moment of opening/closing the door. It may cause some problems with door station operation. In this case it is recommended to use an external power source for lock supplying as it shown on the Pictures 4.9, 4.10.

ATTENTION!

Power supplying using both PoE and the «G» and «12V» pins (for NC103P and NC311P controllers) at one time is PROHIBITED!

ATTENTION!

Maximum current rate provided by the NC103P, NC311P controllers for powering door locks and their controllers is 500 mA. If this value will be exceeded the device may operate incorrect and be damaged. The device breakdown caused by the exceeding of the maximum current rate is not covered by the warranty.

A Z-5R door lock controller is used as an example in the schemes above. This controller supports connection of additional equipment (such as ibutton reader, opened door sensor, etc.) which is not shown on the schemes. See the documentation on the door lock controller you use to connect additional equipment correctly.

Step 15: using the crimped cable connect the RJ45 socket (ETHERNET) of the door station controller (*Pic 3.3, 3.4*) straight to a PoE supported router or by means of a PoE injector if the router does not support PoE (see schemes 2, 3).

If PoE is not used, then connect the RJ45 socket (ETHERNET) of the NC103 controller to a router using the crimped cable and connect the «G» and «12V» pins of the controller with an external DC 12V power source.

To prevent the door station malfunction use only equipment recommended by BEWARD.

4.4. Memory Card Installation

ATTENTION!

Switch off the door station before installation/ejection of the memory card. The hot swap of a memory card is not supported by the door station and may damage the equipment or cause a data loss.

To install/remove a memory card do the following.

Step 1: remove the 4 screws and open the split-type door station housing. The memory card slot is located on the upper interface board, on its back side.

Step 2: take a memory card in a way so that its contacts are facing the interface board and the slot and insert it in the slot; you should feel/hear a click.

To remove the card from the slot push it to feel/hear a click, the memory card will be ejected by a spring.



Step 3: close the split-type door station housing and fix the 4 screws.

4.5. Wired Connection to a Network

Connect the door station controller to the local network (to the router’s LAN interface) using a twisted pair cable with RJ45 connectors.

You can purchase the network cable separately or if you have materials, tools and skills, you can make it by yourself.

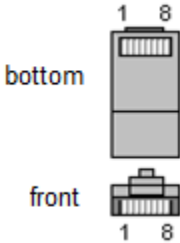
A straight RJ-45 cable (UTP category 5e)

Side A		Side B	
	1: White and orange		1: White and orange
	2: Orange		2: Orange
	3: White and green		3: White and green
	4: Blue		4: Blue
	5: White and blue		5: White and blue
	6: Green		6: Green
	7: White and brown		7: White and brown
	8: Brown		8: Brown

To make a network cable, you need the following materials: a UTP category 5e cable, two RJ-45 connectors and an RJ-45 crimping tool.

Assembling the pairs of wires in the correct order (see the table above) ensures data transfer speed of 100 Mbps.

Chapter 5. Wired Connection Setting

To make the door station work together with computers, laptops and other devices in your local network, you need to connect it to the network according to the network parameters. This chapter explains how to set the network parameters.

NOTE:

The connection establishment process is shown for OS Windows 7 Ultimate. Despite titles of system menus and options may differ from the titles of system menus and options that appear in other Windows versions, the procedure of the connection establishment process is universal.

5.1. Defining the Local Network Parameters for Wired Connection

When connecting the door station via an Ethernet cable, you need to set local network parameters.

To do so, go to **Start – Control Panel** (Pic. 5.1).

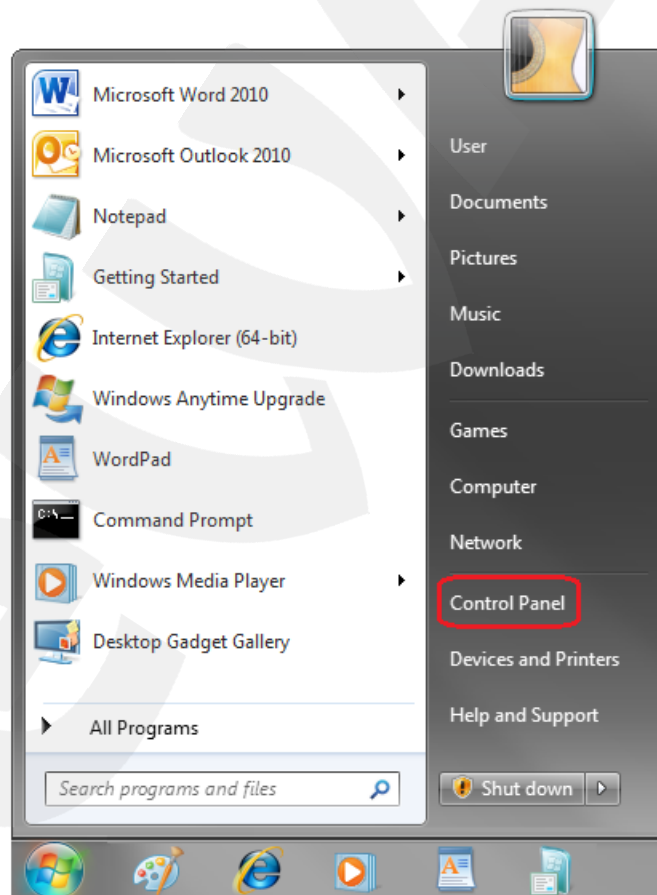

Pic. 5.1

In the new window click **[View network status and tasks]** in the **[Network and Internet]** section (Pic. 5.2).

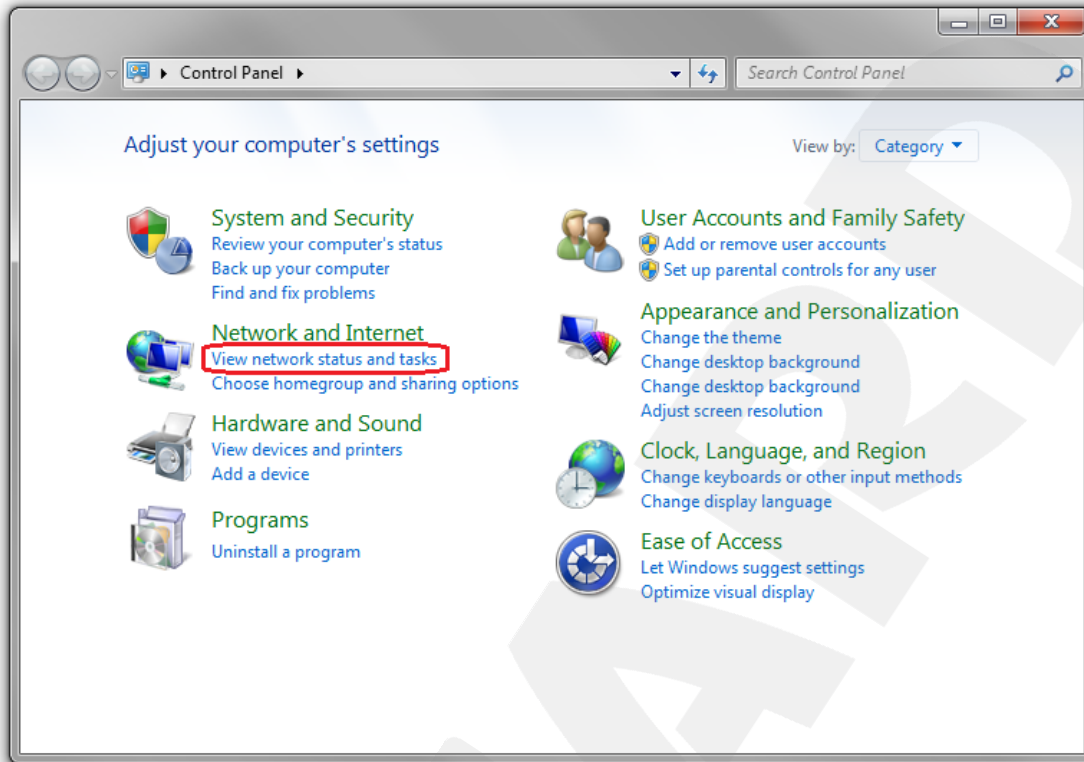

Pic. 5.2

In the new window click **[Local Area Connection]** (Pic. 5.3).

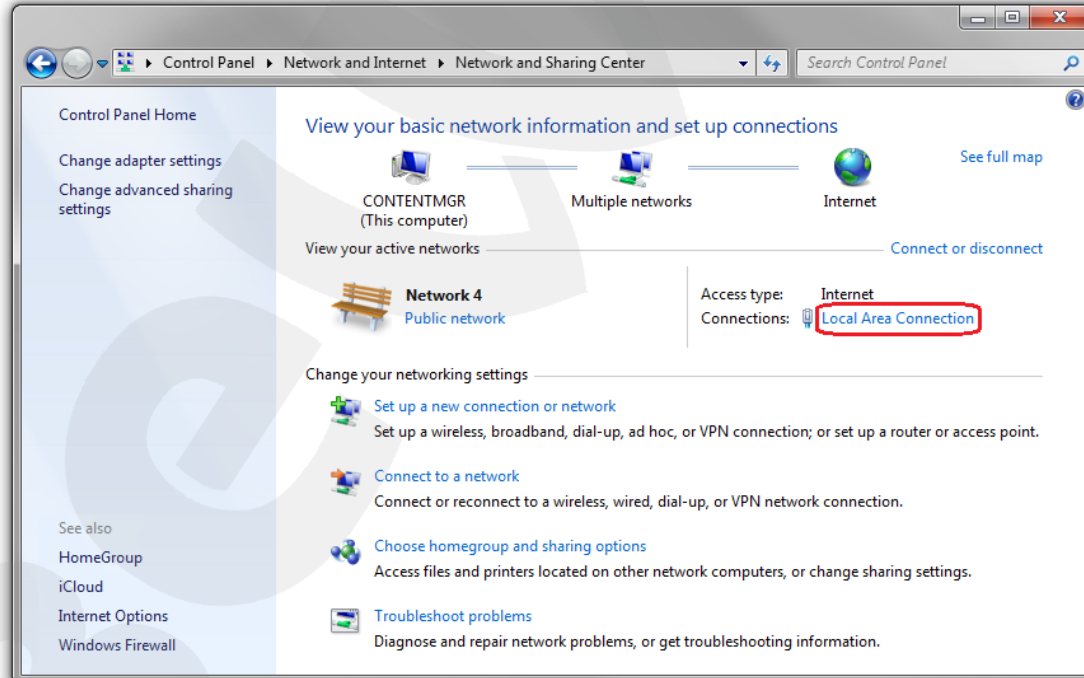

Pic. 5.3

NOTE:

If there are several active networks, choose the one that you are going to connect your door station to.

In the new window click the **[Properties]** button (Pic. 5.4).

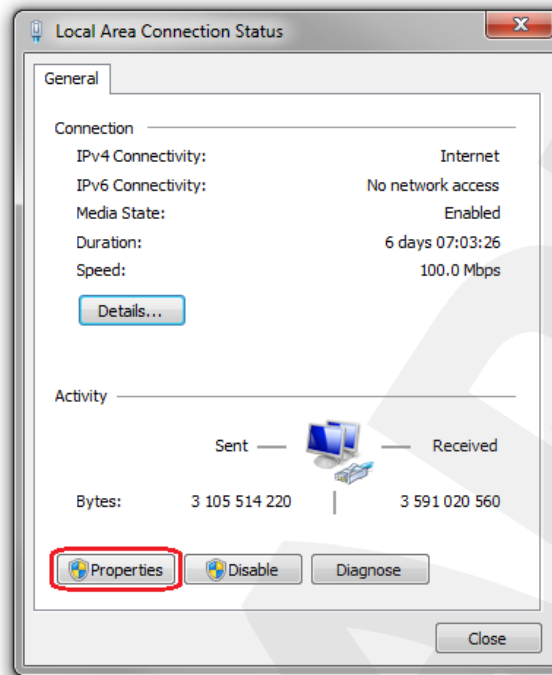

Pic. 5.4

In the opened window select the **[Internet Protocol Version 4 (TCP/IPv4)]** menu item and click the **[Properties]** button (Pic. 5.5).

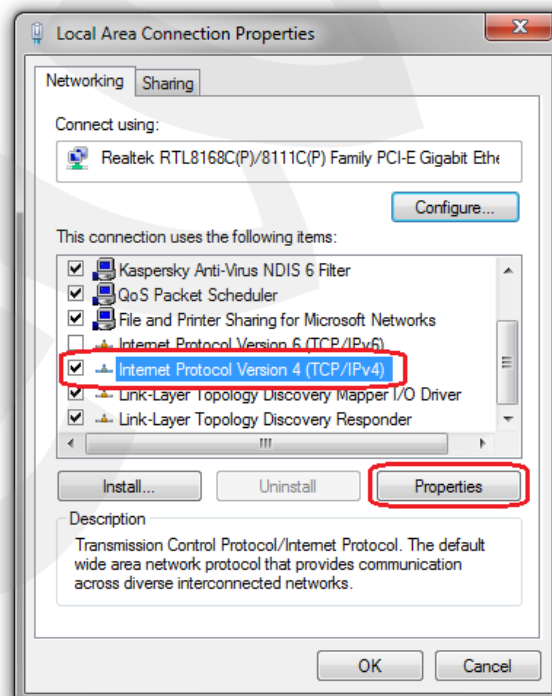

Pic. 5.5

The window opens displaying information about the network connection settings. There are two ways to configure the IP address:

1. Obtain an IP address automatically: select this option to obtain the IP address automatically from a DHCP-server on your network (Pic. 5.6). If the IP address is assigned to your computer automatically, go to paragraph [5.1.1](#) to define the network parameters.

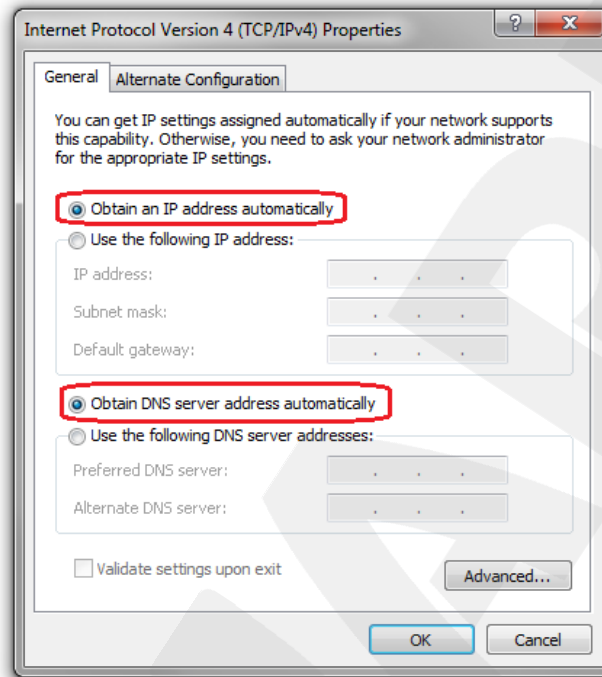

Pic. 5.6

2. Use the following IP address: an IP address is specified manually (Pic. 5.7).

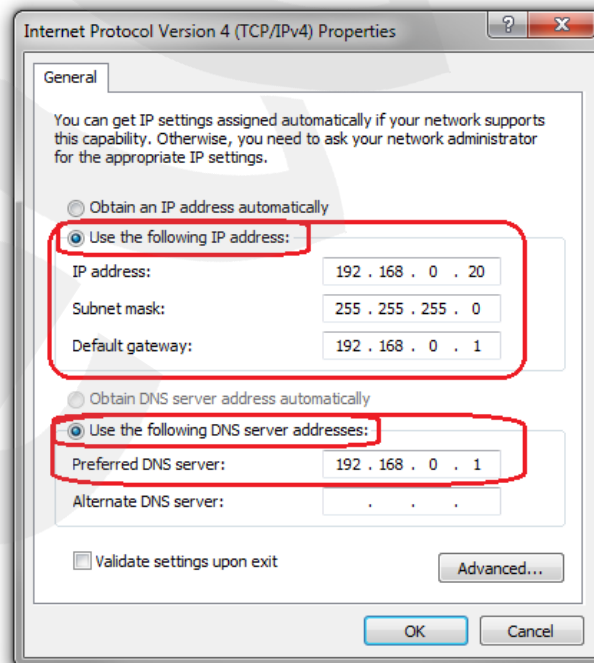

Pic. 5.7

Memorize or write down the following parameters: IP address, Subnet mask, Default gateway, DNS server.

ATTENTION!

If you forget the network parameters it is impossible to return the computer's network settings to their original state and to connect it to a local network or the Internet after configuring the door station.

5.1.1. Defining the Local Network Parameters When Using a Dynamic IP Address**NOTE:**

This paragraph explains how to define the local network parameters if an IP address is assigned to your computer automatically (by DHCP-server).

Connect a computer (laptop) to your local network using a network cable and wait till the connection process completing.

To define the local network settings, go to **Start – Control Panel** (Pic. 5.8).

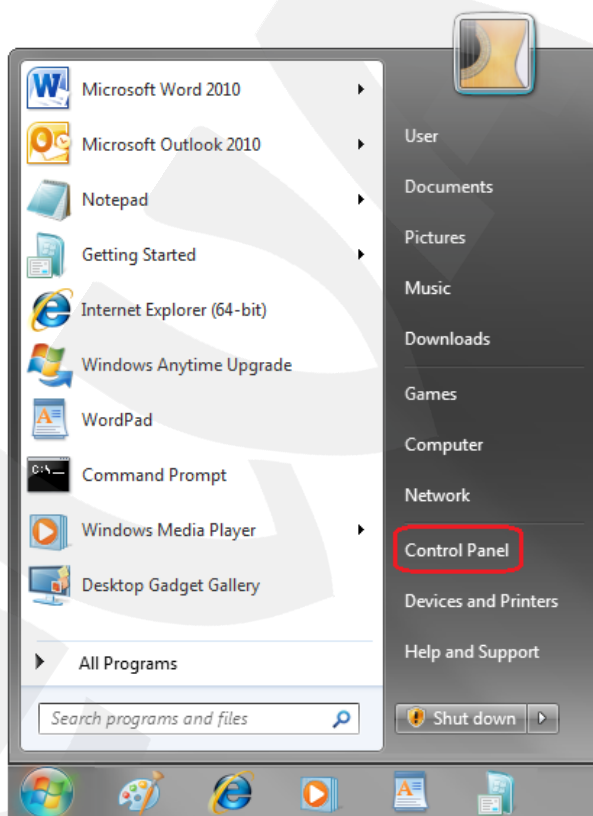

Pic. 5.8

In the opened window click **[View network status and tasks]** in the **[Network and Internet]** section (Pic. 5.9).

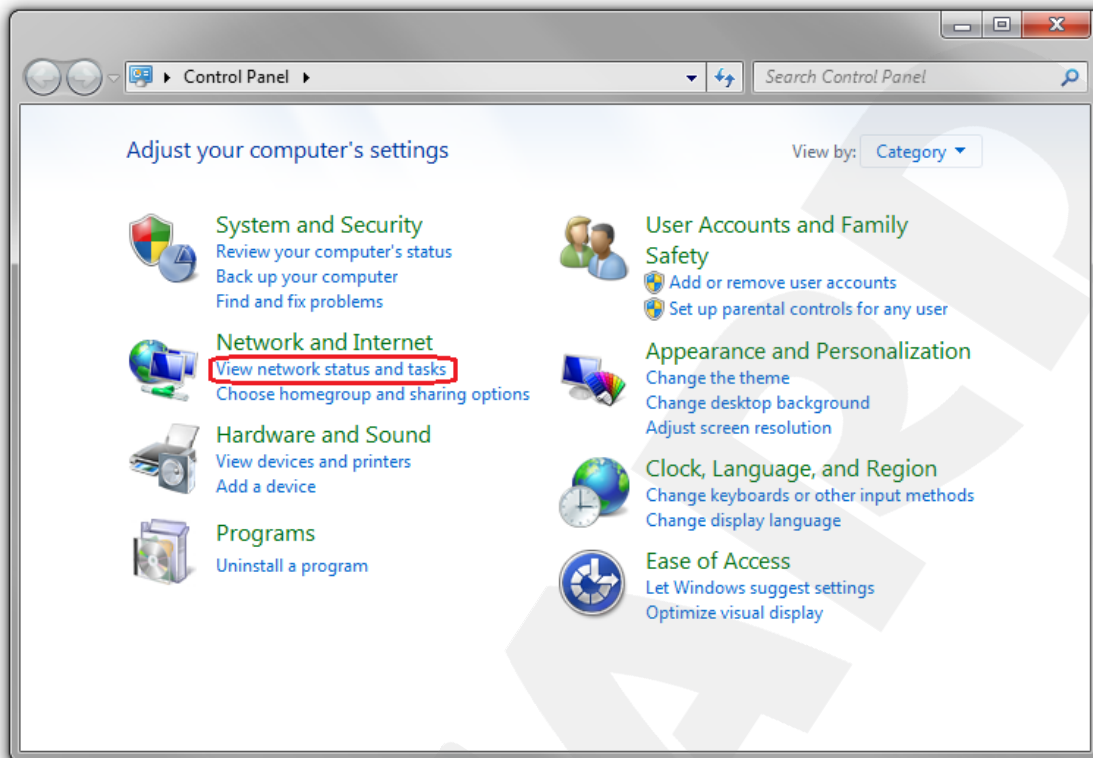

Pic. 5.9

In the new window click **[Local Area Connection]** (Pic. 5.10).

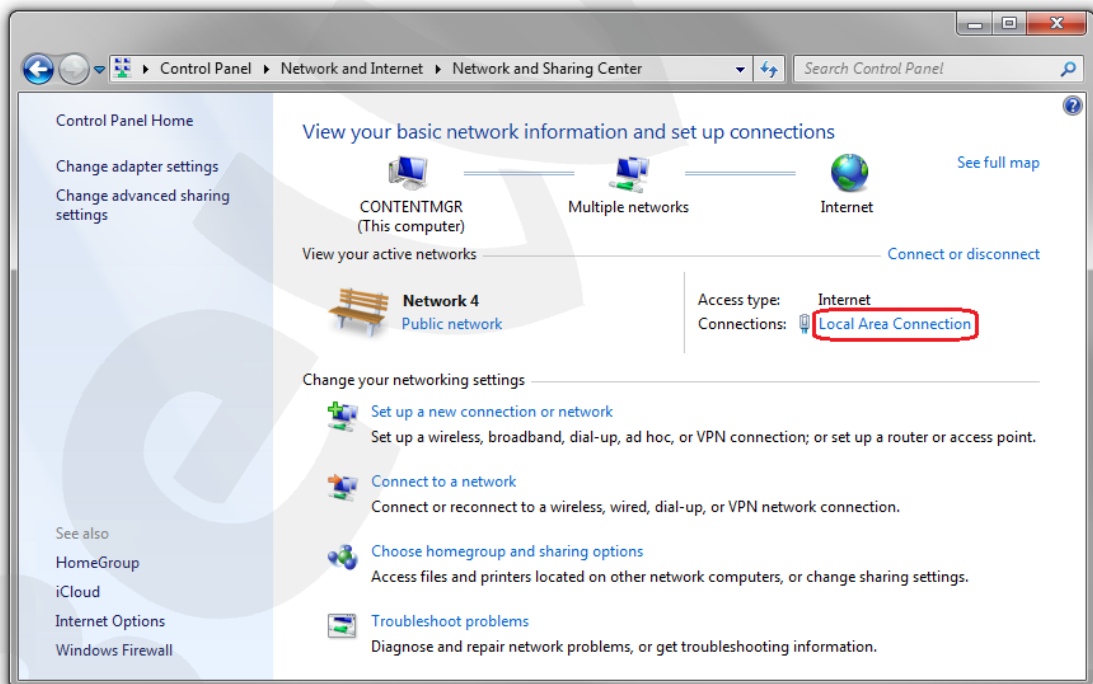

Pic. 5.10

NOTE:

If there are several active networks, choose the one that you are going to connect your door station to.

In the opened window click the **[Details]** button (Pic. 5.11).

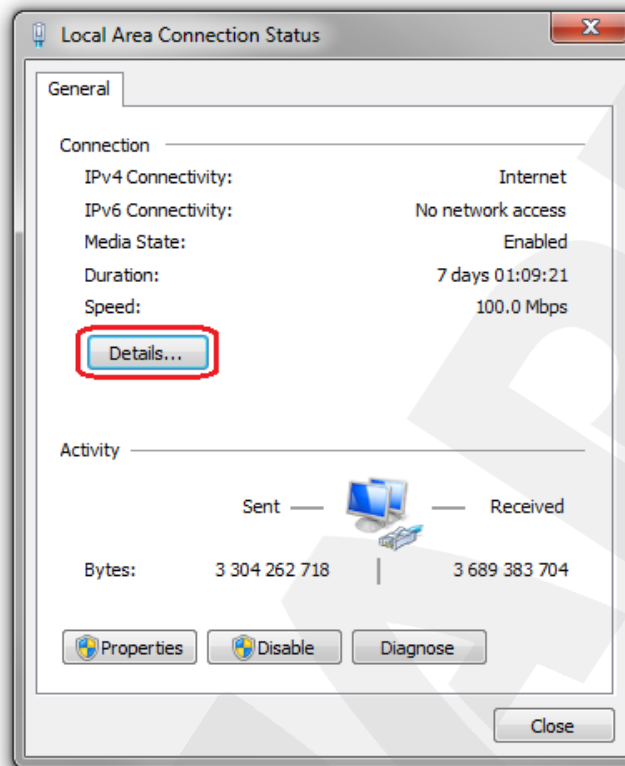

Pic. 5.11

In the opened window you can see the current network connection details (Pic. 5.12).

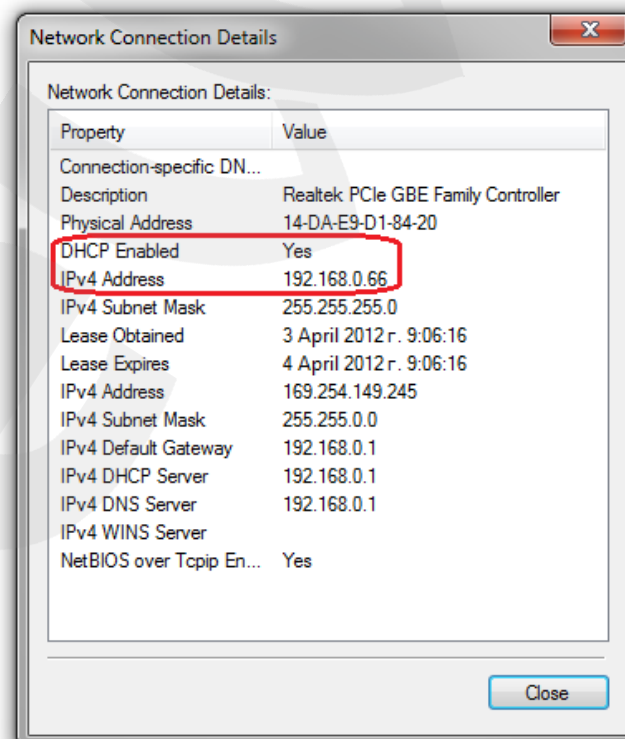

Pic. 5.12

If you will see the following information in the opened window: **[DHCP Enabled – Yes]**, **[IPv4 Address – xxx.xxx.xxx.xxx]** (where xxx.xxx.xxx.xxx is an IP address value), it means that your computer is assigned the IP address displayed in the **[IPv4 Address]** line, the subnet mask displayed in the **[IPv4 Subnet Mask]** line, the gateway address displayed in the **[IPv4 Default Gateway]** line, the DNS server address displayed in the **[IPv4 DNS Server]** line. Memorize or write down these parameters.

ATTENTION!

If you forget the network parameters, it is impossible to return the computer's network settings to their original state and to connect it to a local network or Internet after configuring the door station.

ATTENTION!

If there is the following information in the **[Network Connection Details]** window: **[DHCP Enabled – Yes]**, **[IPv4 Address Autoconfiguration – xxx.xxx.xxx.xxx]** (where xxx.xxx.xxx.xxx is an IP address value), it means that wired connection was not established and a DHCP-server did not assign your computer an IP address. Please check the connection settings or contact your system administrator.

5.2. Changing the Local Network Parameters

The default IP address of the door station is 192.168.0.99. To connect to the door station, make sure it is on the same subnet as your computer. Note that each device must have a unique IP address.

ATTENTION!

The door station's default IP address is **192.168.0.99**. If you use several stations, you need to change their default IP addresses to avoid IP address conflict.

ATTENTION!

If you are sure that your computer and your door station are on the same subnet, you can skip this paragraph and go to paragraph [5.3](#).

To change your computer current network settings, go to **Start – Control Panel** (Pic. 5.13).

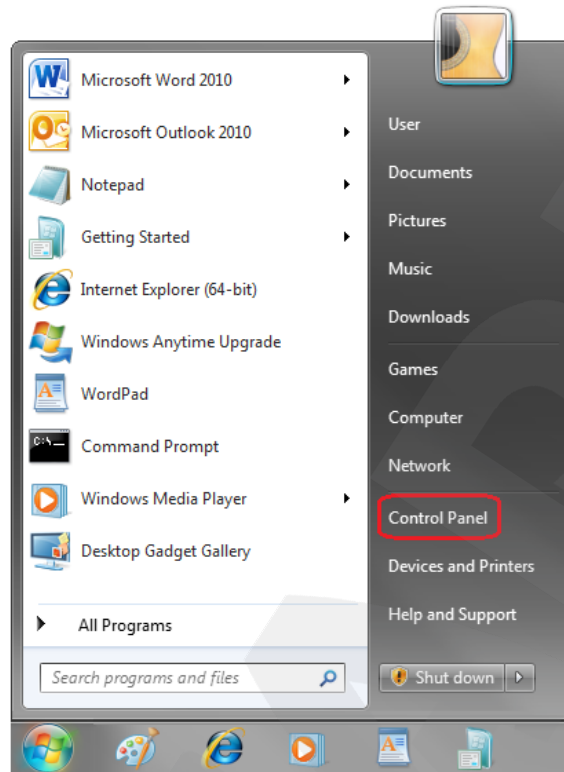

Pic. 5.13

In the new window click **[View network status and tasks]** in the **[Network and Internet]** section (Pic. 5.14).

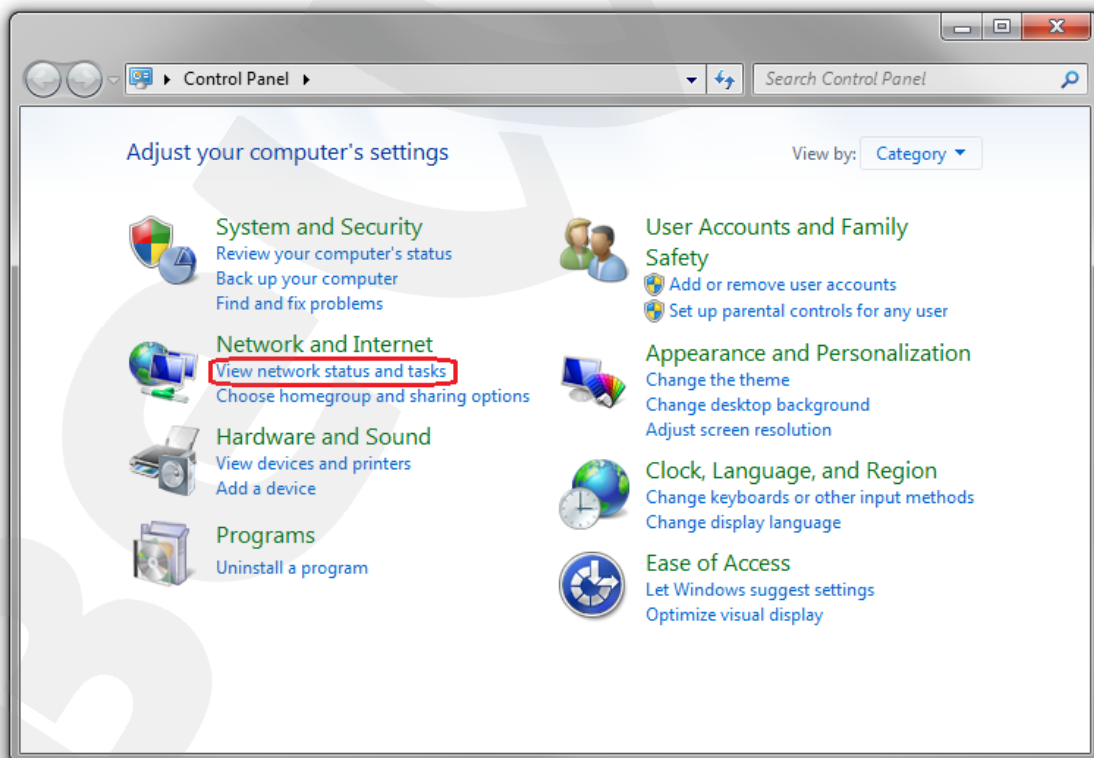

Pic. 5.14

In the new window, click **[Local Area Connection]** (Pic. 5.15).

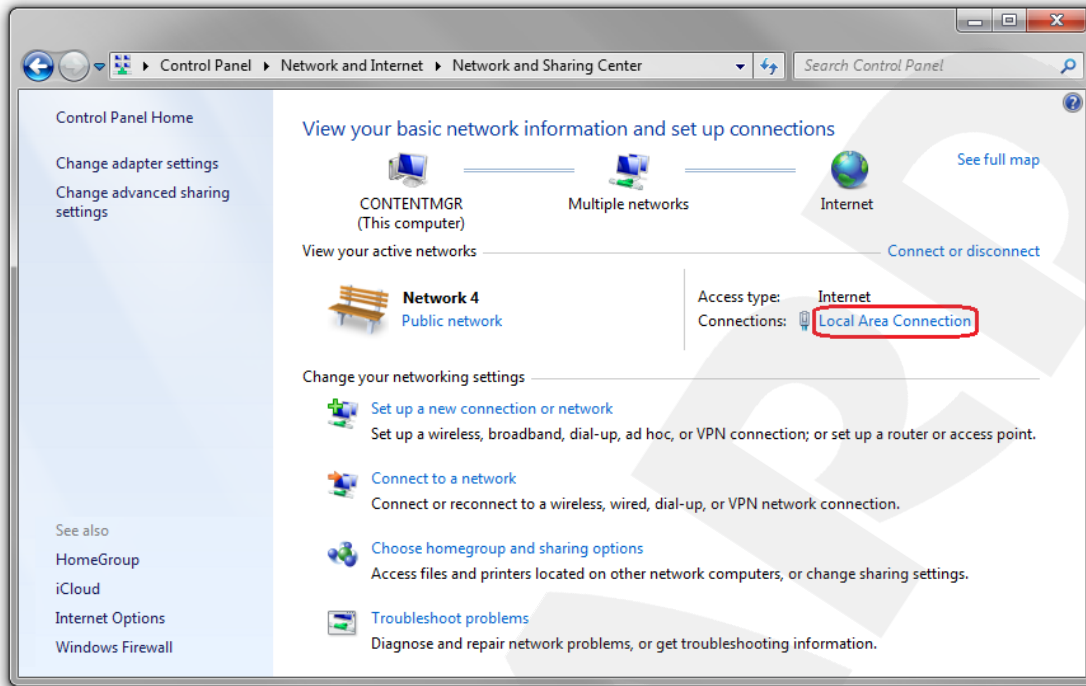

Pic. 5.15

NOTE:

If there are several active networks, choose the one that you are going to connect your door station to.

In the new window, click the **[Properties]** button (Pic. 5.16).

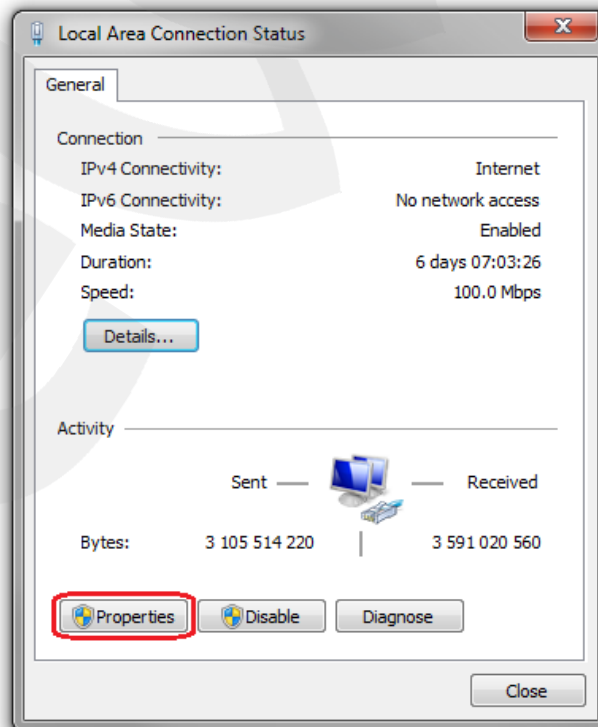

Pic. 5.16

In the connection properties window select the **[Internet Protocol Version 4 (TCP/IPv4)]** menu item and click the **[Properties]** button (Pic. 5.17).

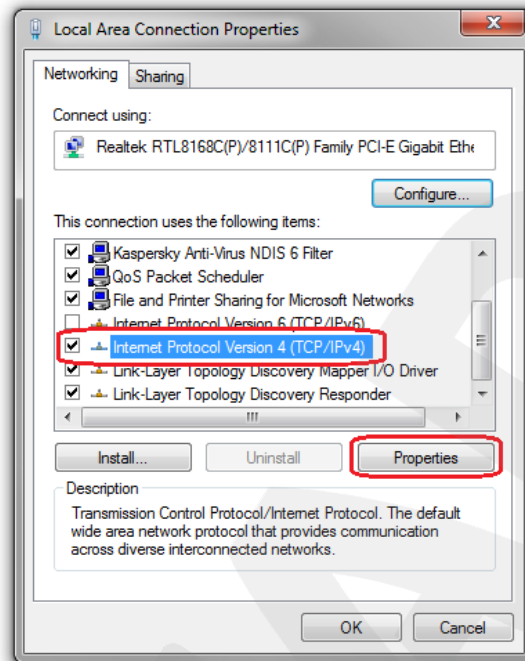

Pic. 5.17

In the new window you need to specify an IP address and a subnet mask. Click the **[Use the following IP address]** and type an unused IP address from the same subnet as the door station, for example, 192.168.0.20, and 255.255.255.0 in the **[Subnet mask]** field. You can skip the other parameters (Pic. 5.18).

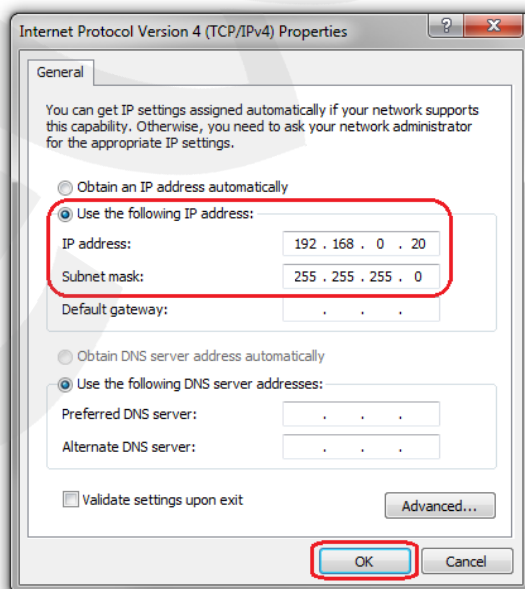

Pic. 5.18

Click the **[OK]** button in all opened windows to save the changes.

5.3. Accessing the Door Station Using Internet Explorer

Launch Internet Explorer to access the door station web user interface (WUI).

NOTE:

To use of the door station web interface Internet Explorer 11.0 or later is required.

Enter the following path in the address field: **http://<IP>:<port>/**, where **<IP>** is the IP address of the door station, **<port>** is the number of the port that is used for HTTP connection to the door station (*Pic. 5.19*).

ATTENTION!

By default, the IP address of the door station is 192.168.0.99 and the http-port is 80.

NOTE:

You do not need enter a port number if you connect via the default HTTP port 80.

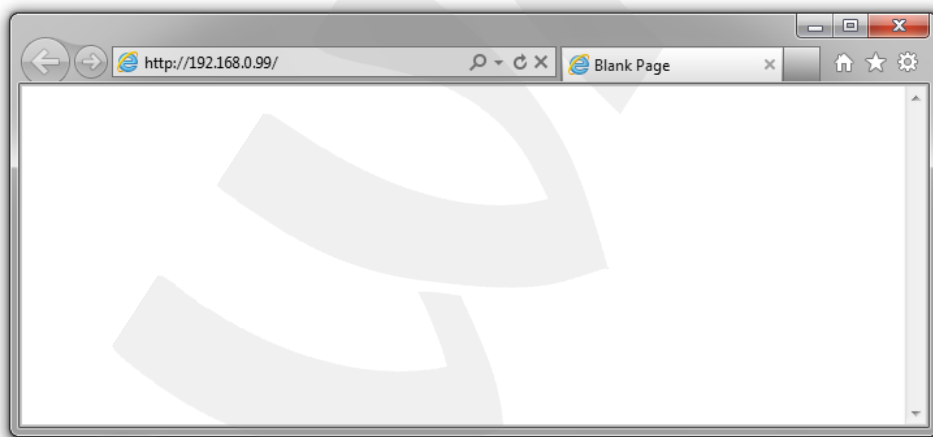

Pic. 5.19

5.4. Accessing the Door Station Web Interface

If the path is correct you will see the authorization window (*Pic. 5.20*).

To work with the door station web interface you need to install the ActiveX add-on. You will see the system notification at the bottom of the window: **“This webpage wants to run the following add-on: “AxMediaControl ActiveX Control Module” from “BEWARD Co., Ltd”** (*Pic. 5.20*).

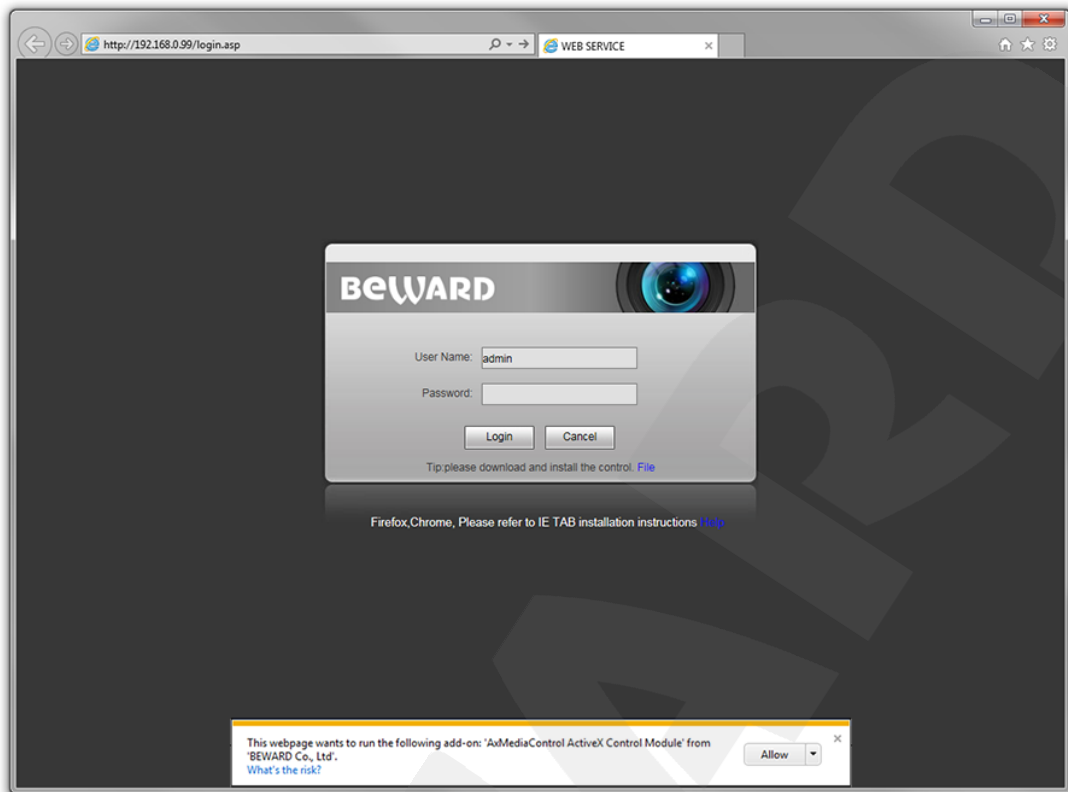

Pic. 5.20

Click **[Allow]** to start installation.

ATTENTION!

Installation of ActiveX components is only possible for 32-bit Internet Explorer.

By default, the Internet Explorer security system blocks ActiveX installation. Click **[Install]** to continue (Pic. 5.21).

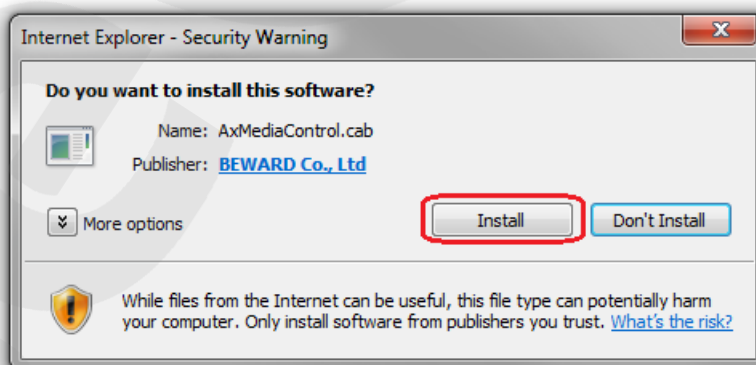

Pic. 5.21

Then you will see the following window (Pic. 5.22):

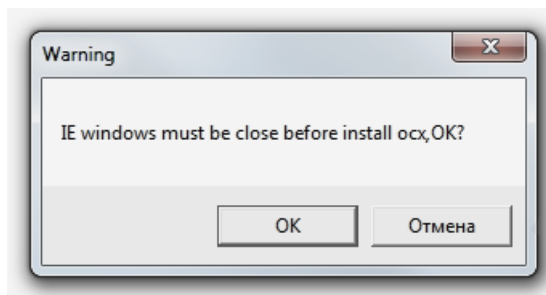

Pic. 5.22

Close Internet Explorer and click **[OK]**. You need close the browser before installation anyway, whether the window on the *Picture 5.22* will appear or not.

The installation window will appear. Click **[Install]** (*Pic. 5.23*).

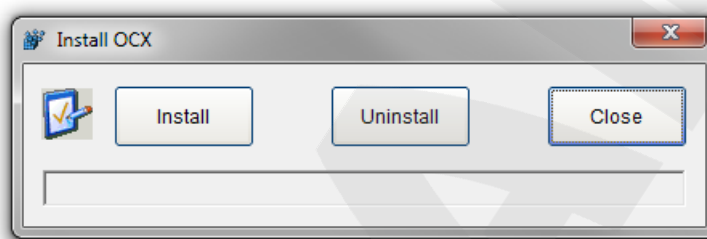

Pic. 5.23

After the installation is complete you will see the following notification: «Register OCX success(C:\)» (*Pic. 5.24*). Click **[Close]** to finish ActiveX installation.

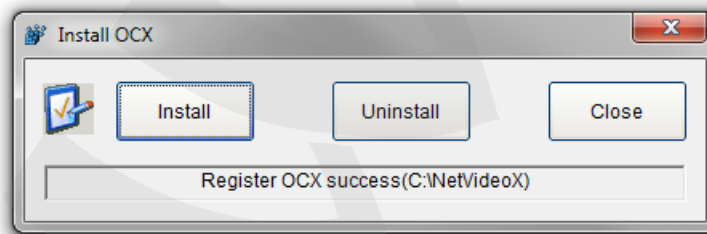

Pic. 5.24

NOTE:

Titles of system menus and options in Windows 7 and Internet Explorer 11.0 may differ from other operating systems and web browsers.

NOTE:

There is one more ActiveX installation blocking in Windows 7 with enabled user account control. In this case you will see an additional system notification. Give a positive answer in the notification window to permit installation.

Open Internet Explorer, enter door station's IP address and press **[Enter]**. Enter username and password (admin / admin) and click **[Login]** (*Pic. 5.25*).

ATTENTION!

You can change login and password in the menu **Config – System – Access Policy** after authorization. If you lost your login or password, you can restore the default settings of the door station. To set the device by default press the reset button 3 times during 10 seconds with 1 second or more between the pushes.

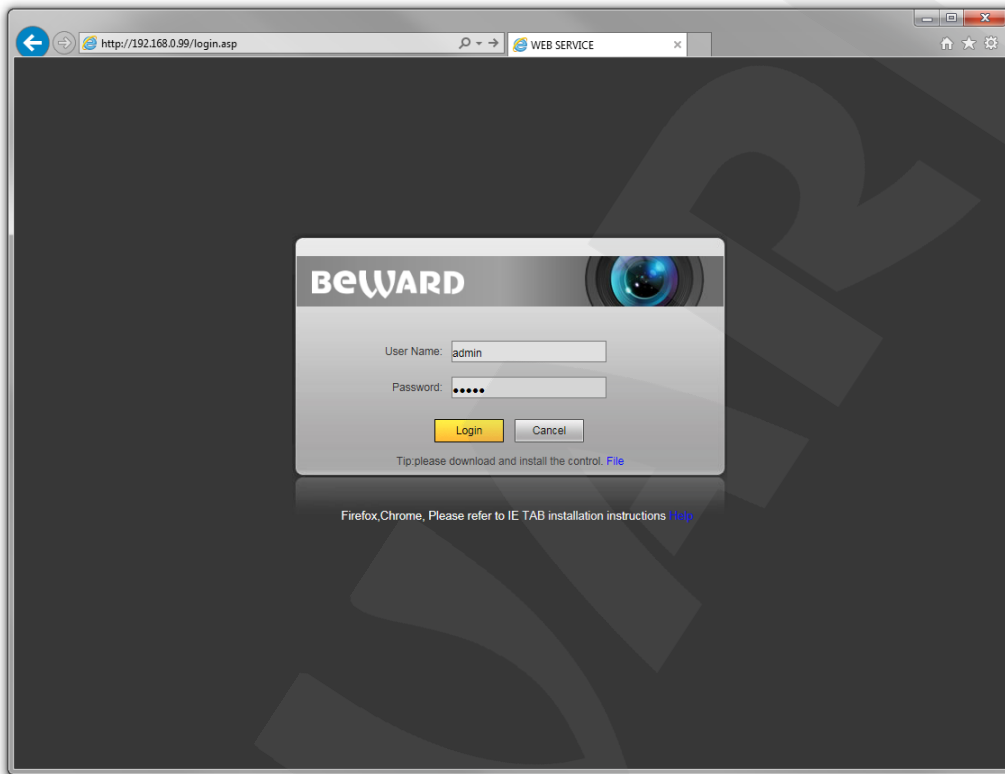

Pic. 5.25

If everything is done correctly, you will start receiving the video stream from the door station's camera (Pic. 5.26).

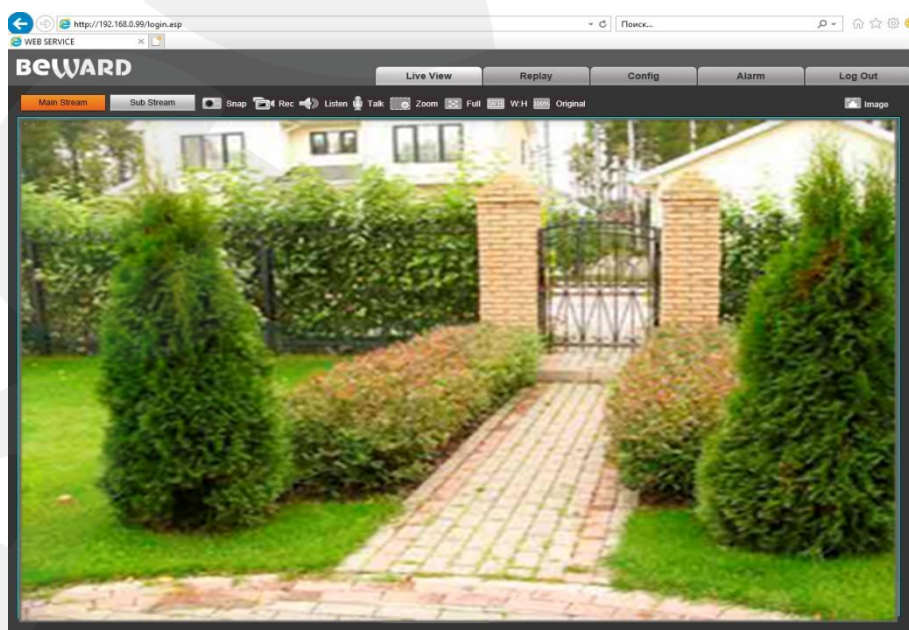

Pic. 5.26

If you failed to install ActiveX correctly you can do it again by clicking the link in the authorization window (*Pic. 5.27*) and following the instructions above.

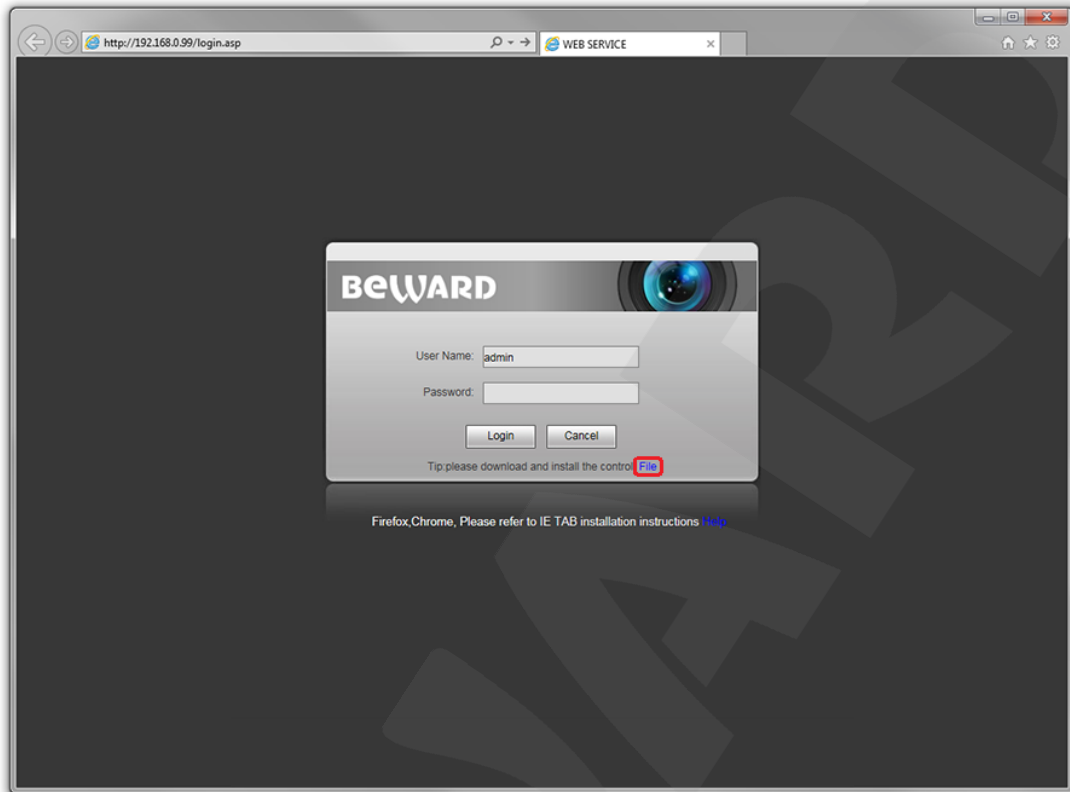

Pic. 5.27

5.5. Configuring Door Station Network Settings through the Web Interface

After connecting the door station to the local network you need to change its network parameters to get it and your other devices (e.g. computer, laptop etc.) to the same subnet.

ATTENTION!

To make your door station and your computer work together, the first three parts of their IP addresses must be identical but the fourth must differ.

For example, the IP address of your computer is 192.168.0.40. An IP address consists of four octets separated by dots. In the provided example, the 1st octet is 192, the 2nd octet is 168, the 3rd octet is 0, and the 4th octet is 40. You need to change the IP address of your door station so that the first three octets of its IP address were the same as your computer's IP address. Therefore, the IP address of your door station must be of the form 192.168.0.xxx. You only need to change the fourth octet to a number different from the IP address of your computer and other network devices.

To configure the network settings through the web interface, click the **[Config]** button and go to the **Network Settings – LAN** (Pic. 5.28).



Pic. 5.28

In the fields **[IP Address]**, **[Subnet Mask]**, **[Gateway]**, **[Main DNS]**, **[Sub DNS]** you need to enter such values which provide joint work of the door station and other devices in the same subnet. To do so apply to the settings you had to write out or save in the paragraphs [5.1](#) or [5.1.1](#).

NOTE:

Contact your system administrator if you need help.

Click **[Save]** to save the changes.

After rebooting the door station will be available on the IP address you specified.

Configuring the door station network settings is completed.

5.6. Restoring Network Settings of PC to the Previous Values

To restore the wired connection settings to their previous values, follow the steps below.

Go to **Start – Control Panel** (Pic. 5.29).

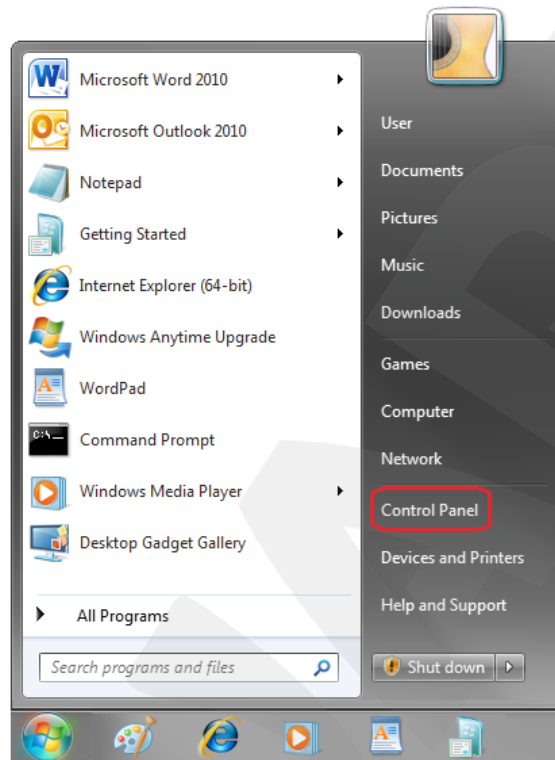

Pic. 5.29

In the new window, click **[View network status and tasks]** in the **[Network and Internet]** section (Pic. 5.30).

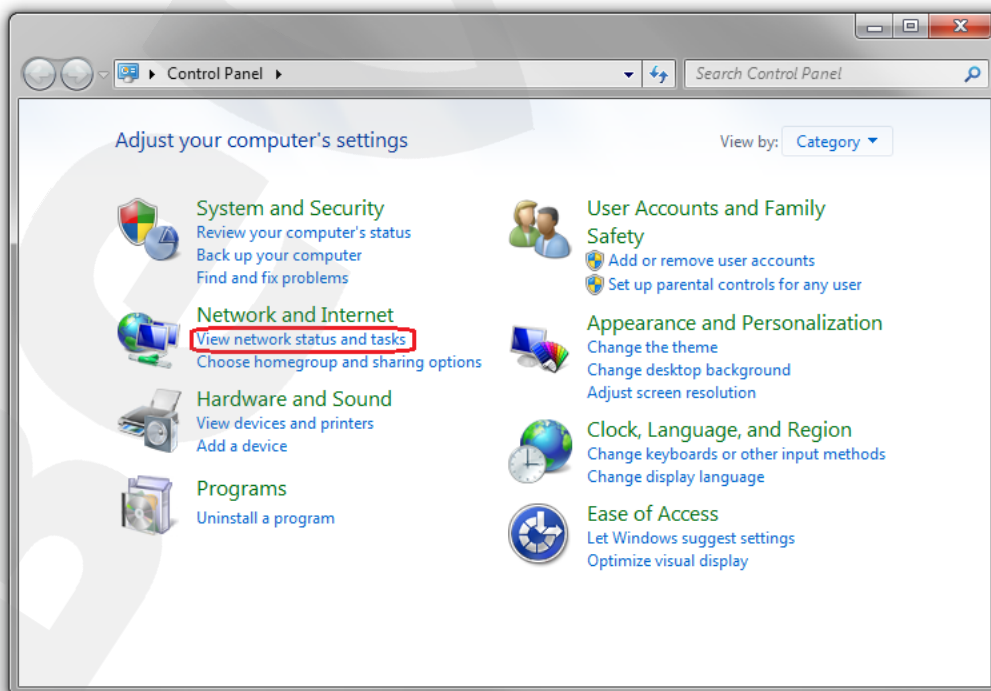

Pic. 5.30

In the new window, click **[Local Area Connection]** (Pic. 5.31).

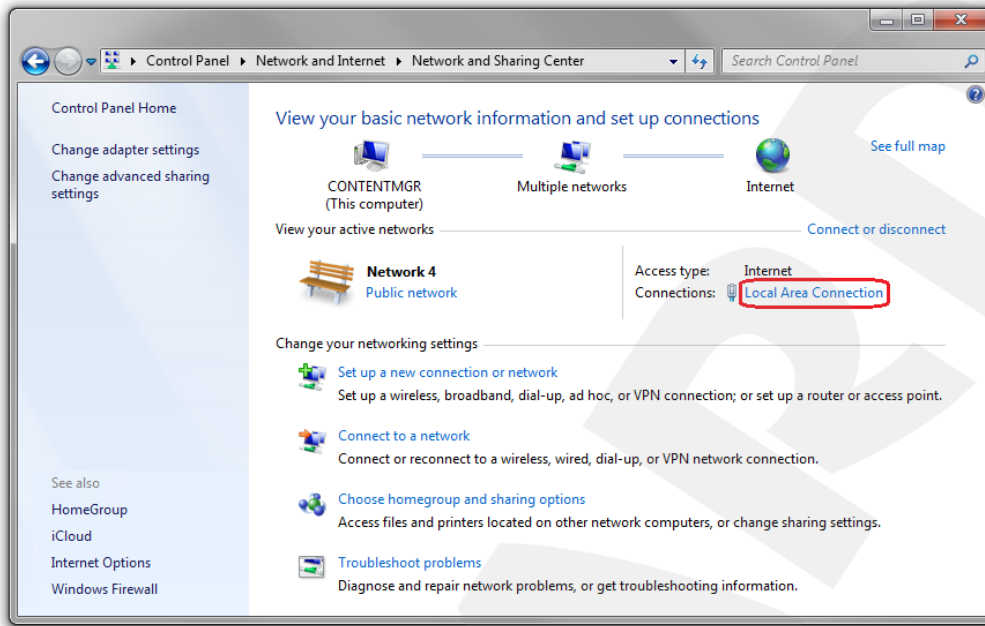

Pic. 5.31

In the new window, click the **[Properties]** button (Pic. 5.32).

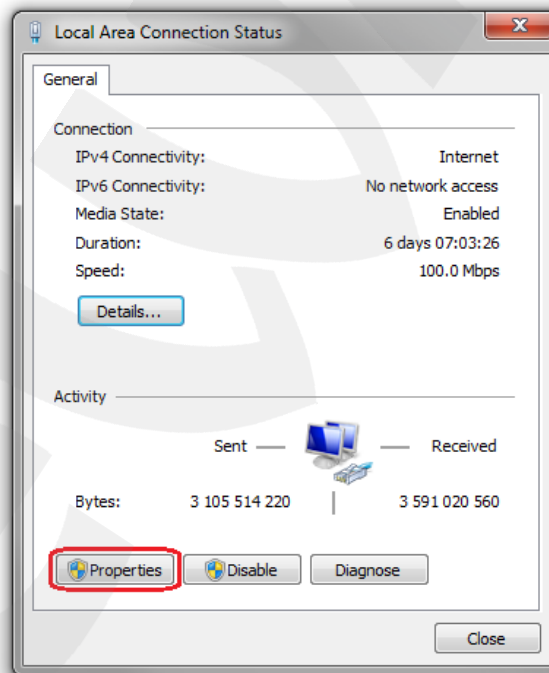

Pic. 5.32

Select the **[Internet Protocol Version 4 (TCP/IPv4)]** menu and click the **[Properties]** button (Pic. 5.33).

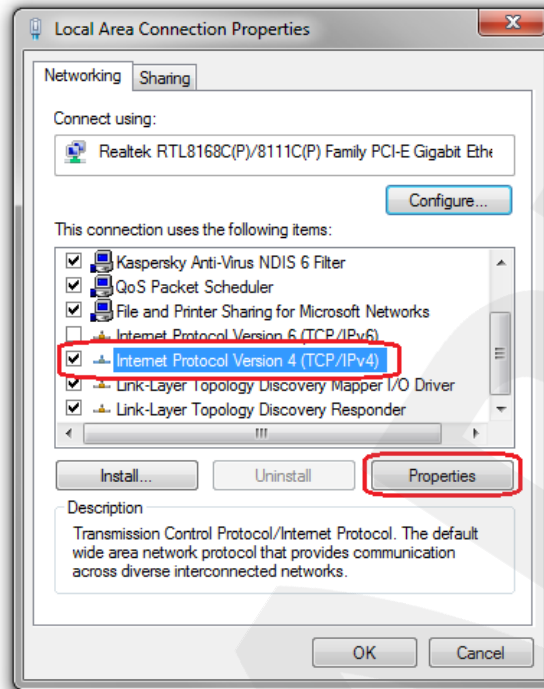

Pic. 5.33

In the new connection properties window you need to specify your initial network settings (see paragraphs [5.1](#), [5.1.1](#)).

If the IP settings were assigned automatically, use the **[Obtain an IP address automatically]** and the **[Obtain DNS server address automatically]** options (Pic. 5.34), then click **[OK]**.

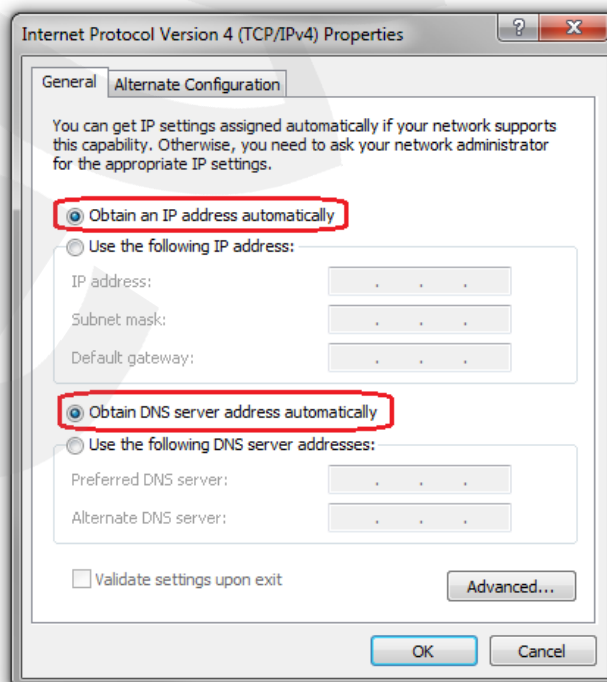

Pic. 5.34

If the IP settings were specified manually, use the **[Use the following IP address]** and the **[Use the following DNS server addresses]** options and complete the required fields (see paragraph 5.1), then click **[OK]** (Pic. 5.35).

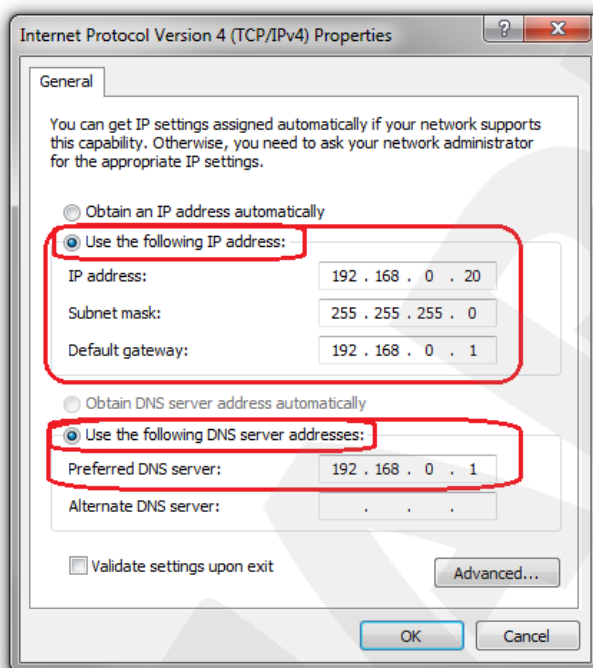

Pic. 5.35

5.7. Verifying the Connection Settings

To verify the network settings of your door station and your computer, you must access the station via Internet Explorer.

To launch Internet Explorer go to **Start – All Programs** and click **[Internet Explorer]**.

Enter the IP address of your door station in the address field (e.g. <http://192.168.0.99>) (Pic. 5.36).

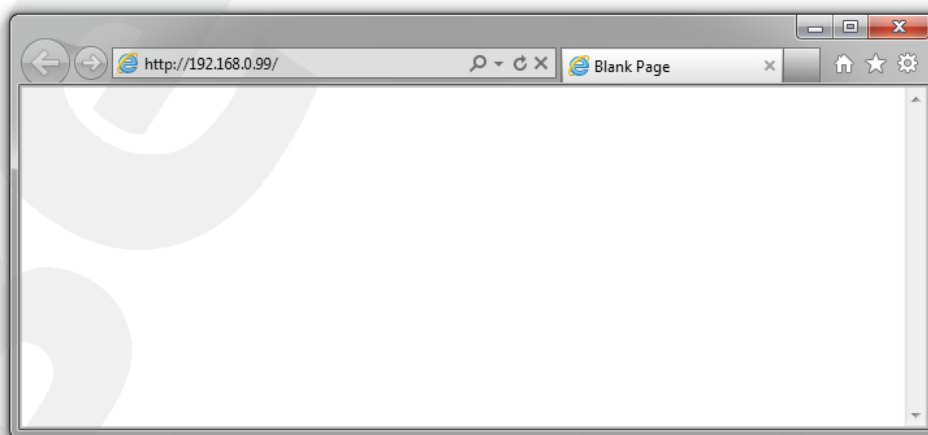

Pic. 5.36

If the settings are correct, the authorization window will appear. Enter the username and password, then click **[OK]** (*Pic. 5.37*).

ATTENTION!

The default username is **admin**, the default password is **admin**.

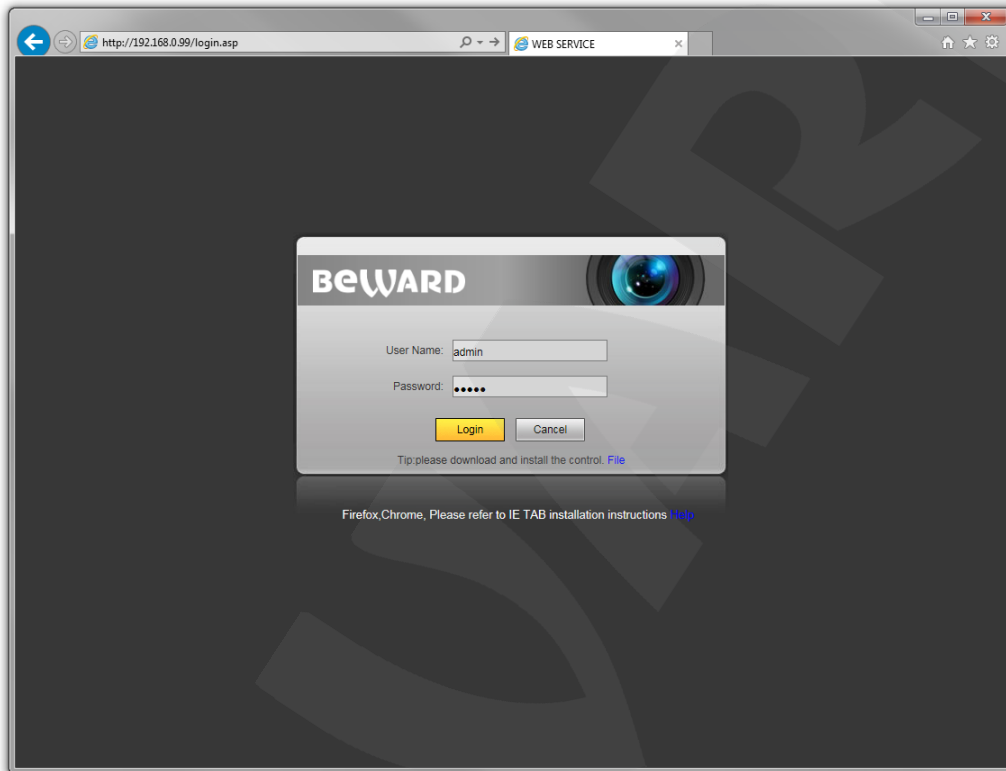

Pic. 5.37

If everything is done correctly, you will see the video image on your display (*Pic. 5.38*).

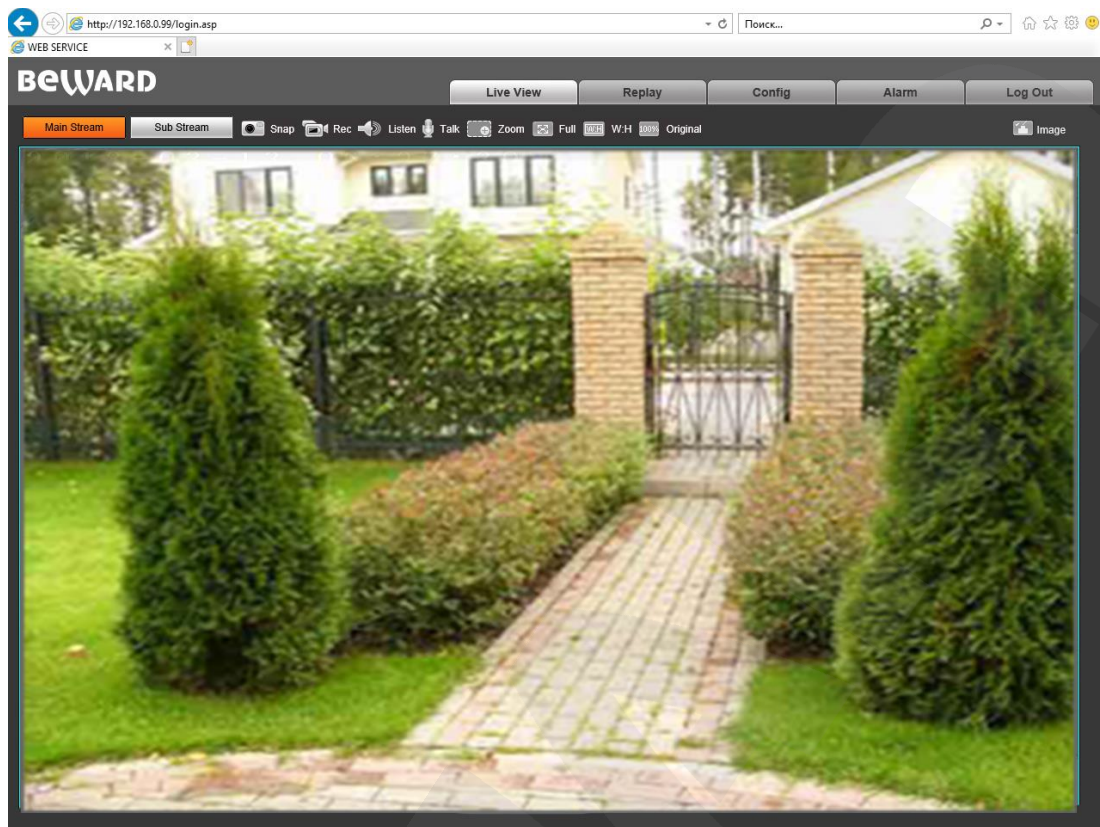

Pic. 5.38

NOTE:

If the video image did not appear on your display, return to the [beginning of the chapter](#) and check the settings step by step. Contact your system administrator if you need help.

Chapter 6. Recommendations on Setting and Operation of DS06M(P)

IP intercom systems combine different types and configurations of equipment (PCs, laptops, microphones, speakers, etc.). Therefore, correct operation of the whole system depends on proper setting of each device used taking into account the peculiarities of their joint operation.

6.1. Acoustic Echo Cancellation

Using the door station the Client or the Guest may hear an echo feedback from their PC speakers or the door station speaker accordingly.

The echo feedback on the Guest side (door station speaker) depends on settings of audio output equipment of Client's PC as well as on audio settings in the operating system on Client's PC.

The echo feedback on the Client side (PC speakers) depends on the door station settings.

The echo feedback may occur when one or more of the following conditions are taken place:

- Microphone Boost level is too high;
- The speakers are too close to the microphone;
- The speaker volume is turned up so as the microphone hears the speakers;
- The microphone is very sensitive.

The most efficient method to remove the echo feedback effect on the Client side is use of headphones or a hands-free unit by the Client for a conversation with the Guest. If this is impossible according to some reasons, follow the recommendations below.

There are two main ways of reducing the echo feedback effect: **change of audio settings in the operating system** and **change of audio settings of the door station**.

1. To reduce the echo feedback effect on the Guest side (door station speaker) by changing settings of the operating system do as follows:

- go to **Control Panel – Sound – Recording**, double-click the recording device set by default (microphone) and ensure that the “**Listen to this device**” option is disabled on the **Listen** tab.
- go to **Control Panel – Sound – Playback**, double-click the playback device set by default and ensure that the “**Microphone**” option is disabled on the **Levels** tab (button ).

It is also possible to reduce the echo feedback effect by selecting the **Enhancements** tab on the microphone's properties page and enabling one of the following options:

- Enable Noise Suppression
- Enable Acoustic Echo Cancellation

NOTE!

These settings are audio hardware and software specific and may not be available for all microphones.

NOTE!

The names of options in the OS menus may differ from the ones mentioned above.

2. Some features of functionality of the door station can be effectively used to reduce the echo feedback effect on the Client side (PC speakers). In the Web User Interface menu go to **Config – Audio Settings – Audio Parameter** and put a tick in the “**Echo Cancellation**” checkbox (see the Operation User Manual).

6.2. Sound Gain and Volume Adjusting

1. If the Client can't hear the Guest well or his voice is interrupted, or if the Guest hears his echo, then change your operating system settings as follows:

- go to **Control Panel – Sound – Recording**, double-click the recording device set by default (microphone) and reduce microphone boost level and volume level (if necessary) on the **Levels** tab. It is recommended to set microphone boost level to 0 dB, volume level to 100. It is also necessary to ensure that the “**Listen to this device**” option is disabled on the **Listen** tab.
- reduce volume level of the PC speakers to the minimal appropriate level. If it is too high, then the microphone may receive the audio waves from the speakers and, therefore, the Guest may hear his echo as well as the Client may hear the Guest with interrupts.
- place the PC microphone farther from the speakers and closer to Client's face.

Moreover, you can adjust the gain of sound transmitted from the door station microphone to the PC speakers in the Web User Interface. Go to **Config – Audio Settings – Audio Parameter** and change the “**Input Volume**” parameter to the appropriate value. The lower “Input Volume” value, the quieter Guest's voice and his echo, and vice versa.

2. If the Guest can't hear the Client well or his voice is interrupted, then change your operating system settings as follows:

- go to **Control Panel – Sound – Recording**, double-click the recording device set by default (microphone) and increase microphone boost level on the **Levels** tab. Then, set appropriate volume level. It is recommended to set microphone boost level to 0 dB, volume level to 100. Values of the parameters may vary depending on the PC microphone type.
- ensure that the “**Listen to this device**” option is disabled on the **Listen** tab.
- reduce volume level of the PC speakers to the minimal appropriate level.

Moreover, you can adjust the gain of sound transmitted from the PC microphone to the door station speaker in the Web User Interface. Go to **Config – Audio Settings – Audio Parameter** and change the “**Output Volume**” parameter to the appropriate value. The lower “Output Volume” value, the quieter Client’s voice and his echo, and vice versa.

Appendices

Appendix A. Factory Defaults

Parameter	Value
IP address	192.168.0.99
Subnet mask	255.255.255.0
Gateway	192.168.0.1
Username (administrator)	admin
Password (administrator)	admin
HTTP port	80
Data port	5000
RTSP port	554
ONVIF port	2000
NTP server	time.nist.gov time.windows.com time-nw.nist.gov time-a.nist.gov time-b.nist.gov

Appendix B. Glossary

Client is person who controls a door station using computer.

Door Station Controller is used for powering the door station, network connection, processing the signal of door opening and signals of other devices that can be connected to the door station.

Guest is a person who presses the call button on a door station installed outside.

IP Video Door Station is a device which is used for controlling the access to some territory or building and provides video surveillance functions due to a built-in IP video camera. The call from the Guest (as he presses the call button) is sent from the door station to the Client's PC or laptop with the installed application. The Client can see the Guest on the monitor of his PC and talk

with him using a microphone and speakers / headphones. The Client can control the electronic door lock and some other devices connected to the door station controller.

PoE Injector is a device that stands between a regular Ethernet switch and the powered device (for example, door station PoE supported controller), injecting power and transferring the data via the same cable.